



# HILTI CFS-CU FIRESTOP CUSHION

Technical Data Sheet  
ETA N° 08/0213



# FIRESTOP CUSHION CFS-CU

The most cost-efficient system available for firestop applications in temporary installations



## APPLICATIONS

- Preformed firestop cushions for sealing temporary or permanent fire penetrations
- Cable penetrations in flexible walls from 100mm and rigid walls from 150mm
- Cables, cable bundles and 50mm PVC pipes

## ADVANTAGES

- Quick and easy installation
- Re-usable and thus economical
- Effective immediately after installation
- Strong durable fabric design
- No special tools required

The European Technical Assessment (ETA) can be obtained via your local Hilti contact.

Technical data	CFS-CU
Intumescent	Yes
Re penetration	Yes
Color	White
Temporary closing	Yes
Singlesided installation possible	Yes
2 <sup>nd</sup> component	for ceiling openings: CFS-S ACR
Reusable (and removable)	Yes
Reaction to fire class	B-s1 d0 (according to EN 13501-1)
Storage temperature	-20°C to +40°C
Application temperature	-20°C to +40°C
Temperature resistance	-20°C to +40°C



Order designation	Sales Quantity	Item number
Firestop cushion CFS-CU L	6	02007447
Firestop cushion CFS-CU M	15	02007446
Firestop cushion CFS-CU S	30	02007445

# INSTALLATION INSTRUCTIONS

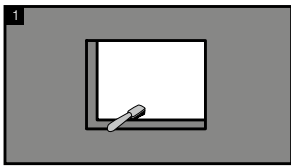

Clean the opening.

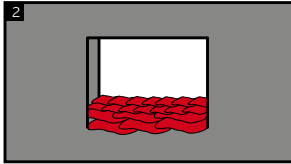

Cushion arrangement without cables running through wall partition.

Opening must be framed in drywall applications.

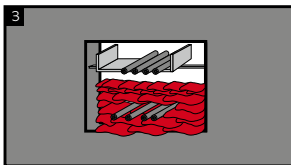

Cushion arrangement with cables/ cable trays running through wall partition.

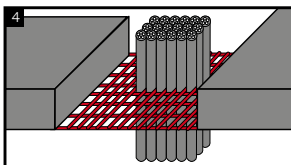

When closing floor openings, fasten wire mesh in place as shown in drawing.

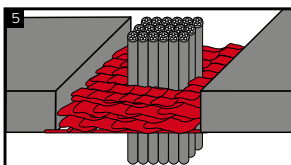

Cushion arrangement in floor. If required, seal gaps between cables and Hilti Firestop Cushions with Hilti Acrylic Sealant CFS-S ACR (please refer to approval).

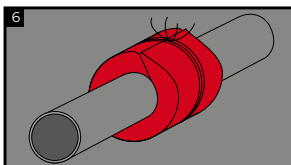

If required by approval, wrap cable/ cable tray resp. pipe with Hilti Firestop Cushion

CFS-CU L and fix with wire as shown in drawing.

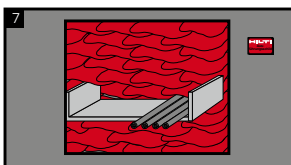

Fasten identification plate in place if required.

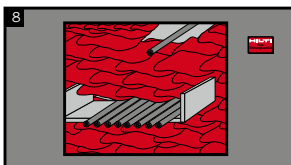

Re-installing cables or pipes:

Remove a Hilti Firestop Cushion from the seal and install the cable or pipe.

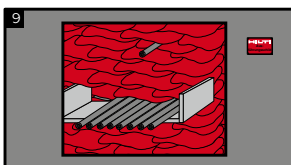

Close the opening with Hilti Firestop Cushions in compliance with the approval.

# CABLE, CONDUIT AND PIPE PENETRATION

## Flexible Wall | Rigid Wall

The intended use of the Hilti Firestop Cushion CFS-CU is to reinstate the fire resistance performance of:

Flexible walls/drywalls (E), with a minimum thickness 100 mm ( $t_E$ ) with timber or steel studs lined on both faces with a minimum of two layers of 12.5 mm thick boards. For timber stud walls there must be a minimum distance of 100 mm between the seal and any stud, and the cavity must be filled with a minimum of 100 mm of Class A1 or A2 insulation in accordance with EN 13501-1.

Rigid walls (E) consisting of concrete, aerated concrete or masonry, minimum density of 650 kg/m<sup>3</sup>, minimum thickness 100/150 mm ( $t_E$ ).

Maximum opening size (w x h) 1200 mm x 1500 mm in flexible and rigid walls.

### WALL ≥ 100 MM

Penetration seal (A)/services (C)	Wall type and thickness ( $t_E$ )	Classification E = Integrity I = Insulation	Other criteria Description Minimum distances ( $s_1, s_2$ )
All sheathed cable types up to 80 mm diameter		EI 45 / E 120	
Tied cable bundles up to 80mm overall diameter, containing sheathed cables up to 21 mm diameter			<b>No additional cable wrapping with CFS-CU L</b>
All non-sheathed electrical cables up to 24 mm diameter	Flexible wall Rigid wall ≥ 100 mm		Minimum distances: cable/cable tray to seal edge ( $s_1$ ) = 40 mm cable to cable ( $s_2$ ) = 0 mm cable to cable bundle ( $s_2$ ) = 80 mm cable to cable tray ( $s_2$ ) = 80 mm plastic pipe to seal edge ( $s_1$ ) = 100 mm plastic pipe to plastic pipe ( $s_2$ ) = 100 mm plastic pipe to cable tray ( $s_2$ ) = 175 mm
Steel or plastic conduits up to 16 mm diameter		EI 45-U/U / E 120-U/U	
PVC-U pipes (C) according to EN 1452-1 and DIN 8061/8062 diameter 50 mm and pipe wall thickness 1.8–5.3 mm		EI 120-U/C	
All sheathed cable types up to 80 mm diameter		EI 120	
Tied cable bundles up to 80 mm overall diameter, containing sheathed cables up to 21 mm diameter			<b>Additional cable wrapping with CFS-CU L</b>
All non-sheathed electrical cables up to 24 mm diameter	Flexible wall Rigid wall ≥ 100 mm		Minimum distances: cable/cable tray to seal edge ( $s_1$ ) = 40 mm cable to cable ( $s_2$ ) = 0 mm cable to cable bundle ( $s_2$ ) = 80 mm cable to cable tray ( $s_2$ ) = 80 mm
Steel or plastic conduits up to 16 mm diameter		EI 120-U/U	

## RIGID WALL $\geq 150$ MM

Penetration seal (A)/services (C)	Wall type and thickness ( $t_e$ )	Classification E = Integrity I = Insulation	Other criteria Description Minimum distances ( $s_1, s_2$ )
All sheathed cable types up to 80 mm diameter	Rigid wall $\geq 150$ mm	EI 60 / E 240	<p><b>No additional cable wrapping</b></p> <p>Minimum distances:            cable/cable tray to seal edge (<math>s_1</math>) = 40 mm            cable to cable (<math>s_2</math>) = 0 mm            cable to cable bundle (<math>s_2</math>) = 80 mm            cable to cable tray (<math>s_2</math>) = 80 mm            plastic pipe to seal edge (<math>s_1</math>) = 100 mm            plastic pipe to plastic pipe (<math>s_2</math>) = 100 mm            plastic pipe to cable tray (<math>s_2</math>) = 175 mm</p>
Tied cable bundles up to 80mm overall diameter, containing sheathed cables up to 21 mm diameter			
All non-sheathed electrical cables up to 24 mm diameter			
Steel or plastic conduits up to 16 mm diameter			
PVC-U pipes (C) according to EN 1452-1 and DIN 8061/8062 diameter 50 mm and pipe wall thickness 1.8–5.3 mm		EI 45-U/U / E 240-U/U	
All sheathed cable types up to 80 mm diameter	Rigid wall $\geq 150$ mm	EI 120 / E 240	<p><b>Additional cable wrapping with CFS-CU L</b></p> <p>Minimum distances:            cable/cable tray to seal edge (<math>s_1</math>) = 40 mm            cable to cable (<math>s_2</math>) = 0 mm            cable to cable bundle (<math>s_2</math>) = 80 mm            cable to cable tray (<math>s_2</math>) = 80 mm</p>
Tied cable bundles up to 80 mm overall diameter, containing sheathed cables up to 21 mm diameter			
All non-sheathed electrical cables up to 24 mm diameter			
Steel or plastic conduits up to 16 mm diameter			
		EI 120-U/U / E 240-U/U	

## CABLES | CONDUITS | PIPES

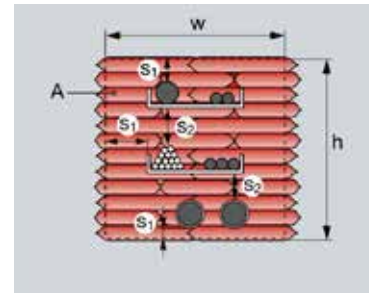
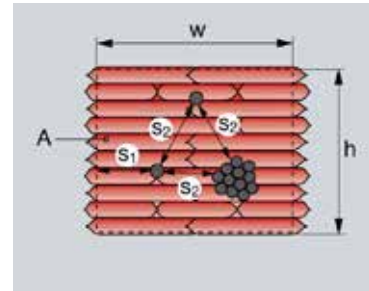
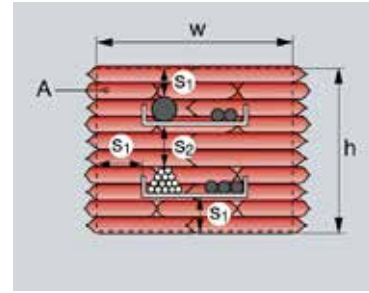
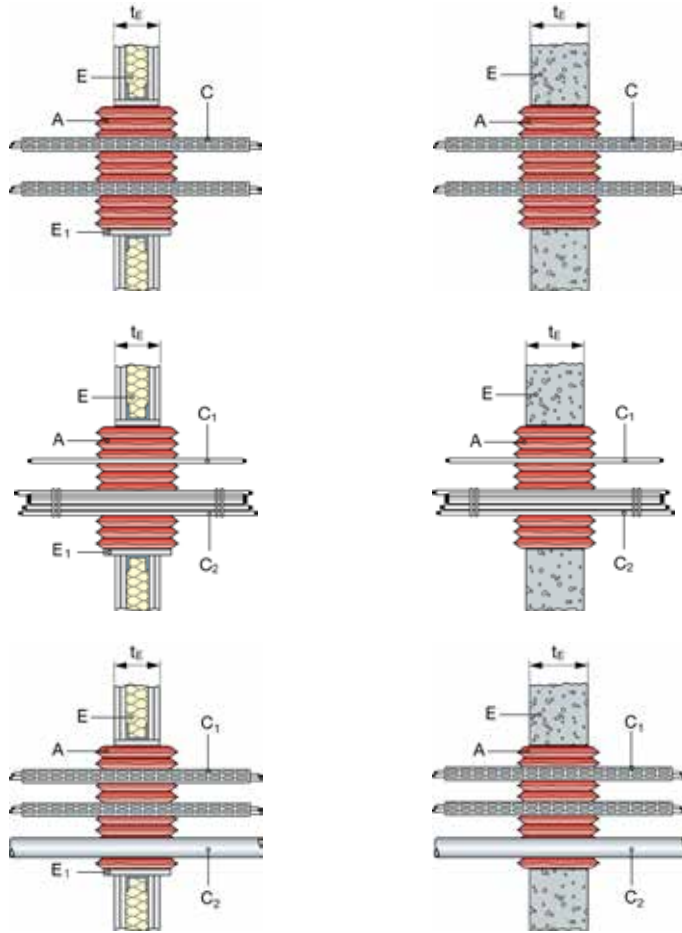

## ADDITIONAL CABLE WRAPPING

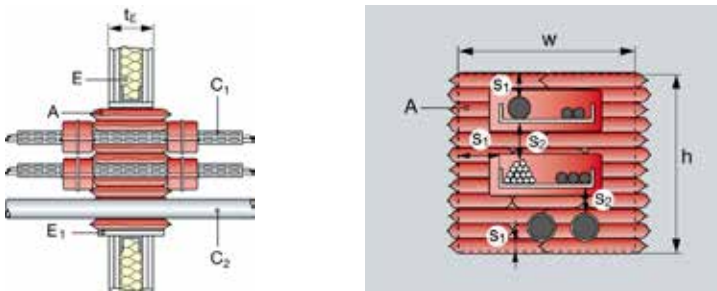

- A<sub>1</sub>, A<sub>2</sub>, A<sub>3</sub>,... Firestop product
- C, C<sub>1</sub>, C<sub>2</sub>,... Penetration Service
- E Building element (wall, floor)
- E<sub>1</sub> Supporting board
- E<sub>2</sub> Wire mesh
- t<sub>E</sub> Thickness of building element (wall, floor)
- t<sub>E1</sub> Length of supporting board
- w width
- h height
- l<sub>A</sub> length Firestop product (additional)

# CABLE, CONDUIT AND PIPE PENETRATION

## Floor

The intended use of the Hilti Firestop Cushion CFS-CU is to reinstate the fire resistance performance of rigid floors, minimum thickness 150 mm ( $t_E$ ), minimum density of 2200 kg/m<sup>3</sup>.

Maximum opening size ( $w \times h$ ) up to 700 mm wide and unlimited length.

Penetration seal (A)/services (C)	Wall type and thickness ( $t_E$ )	Classification E = Integrity I = Insulation	Other criteria Description Minimum distances ( $s_1, s_2$ )
All sheathed cable types up to 21 mm diameter	Rigid floor $\geq 150$ mm	EI 120	
All sheathed cable types diameter 21-80mm		EI 60/E 120	Additional cable wrapping with CFS-CU L (see drawings) ( $I_A = 150$ mm)
Cable bundles up to 80 mm overall diameter containing all sheathed cable types up to 21 mm diameter		EI 60-U/U / E 120-U/U	Minimum distances: cable/cable tray to seal edge ( $s_1$ ) = 40 mm cable to cable ( $s_2$ ) = 0 mm cable to cable bundle ( $s_2$ ) = 80 mm cable to cable tray ( $s_2$ ) = 80 mm plastic pipe to seal edge ( $s_1$ ) = 40 mm plastic pipe to plastic pipe ( $s_2$ ) = 100 mm plastic pipe to cable tray ( $s_2$ ) = 50 mm
All non-sheathed cable types up to 24 mm diameter			
Steel and plastic conduits up to 16 mm diameter		EI 120-U/U	Additional support by wire mesh fixed with metal anchors underneath the seal is required ( $E_2$ ).
PVC-U pipes (C) according to EN 1452-1 and DIN 8061/8062 diameter 50 mm and pipe wall thickness 1.8-5.3 mm			
All sheathed cable types up to 21 mm diameter		EI 120	
All sheathed cable types diameter 21-80 mm		EI 90 EI 120 $I_A = 300$ mm	Additional cable wrapping with CFS-CU L (see drawings) $I_A = 150$ mm <sup>1)</sup> $I_A = 300$ mm + Hilti Firestop Acrylic Sealant CFS-S ACR (A <sub>1</sub> )
Cable bundles up to 80 mm overall diameter containing all sheathed cable types up to 21 mm diameter		EI 90/E 120	Minimum distances: see above
All non-sheathed cable types up to 24 mm diameter		EI 120	Additional support by wire mesh fixed with metal anchors underneath the seal is required ( $E_2$ ).
Steel and plastic conduits up to 16 mm diameter	EI 120-U/U		

## CABLES | CONDUITS | PIPES ADDITIONAL CABLE WRAPPING

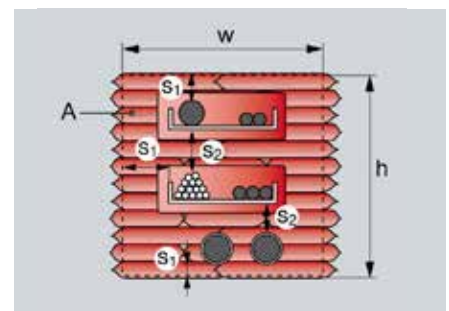
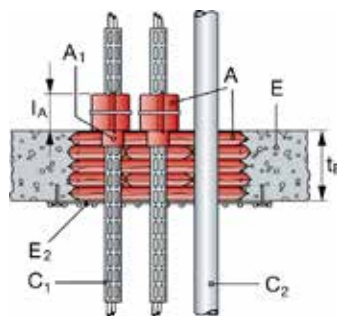
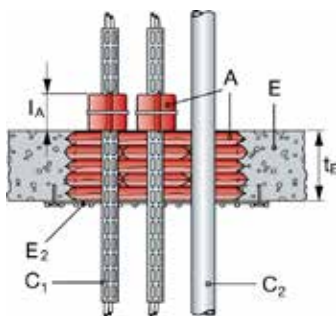

# CHARACTERISTICS OF CFS-CU

## Additional Attributes

Hilti firestop products are comprehensively tested and individually matched to the technical requirements of a building's mechanical and electric installations. In addition to their superior passive fire protection behavior, Hilti firestop products also meet increasingly significant requirements in building technology and also help designers and installers to meet these additional requirements. The assessment of fitness for use has been made in accordance with EOTA ETAG No 026 – Part 2.



Charecteristics	Assessment of charecteristics	Norm, standard, test
<b>Health and the environment</b> Dangerous substances	Below any respective occupational exposure limits as far as such limits exist	Material safety data sheet
<b>Protection against noise</b> (Air borne sound insulation)	$R_w (C; C_{tr}) = 50$ dB $D_{n,e,w} (C; C_{tr}) = 58$ dB	EN ISO 140-3 EN ISO 140-10 EN ISO 717-1
<b>Safety in use</b> Mechanical resistance and stability Resistance to impact / movement	Soft body impact: Energy 300 Nm Hard body Impact: Energy 10 Nm	EOTA Technical Report TR001
<b>Adhesion</b>	It is assumed that verification of adequate adhesion is covered by the impact test (see above).	
<b>Durability and serviceability</b>	Category $Z_2$ (suitable for penetration seals intended for use in indoor dry conditions with humidity classes excluding high humidity and temperatures below 0°C.	EOTA Technical Report TR 024 ETAG 026-2
<b>Reaction to fire</b>	Class B – s <sub>1</sub> , d <sub>0</sub>	EN 13501-1

## SERVICE

With more than 20 years of experience worldwide, Hilti is one of the leading suppliers of firestop systems. We actively help you manage your firestop projects better by providing:

- Quick engineering judgements
- Extensive technical literature
- On-site training and demonstration
- Sophisticated jobsite logistics
- Assurance of conformity with specific application requirements
- International network of Hilti firestop specialists

Our network of experienced sales representatives, field engineers, firestop specialists and customer service representatives is just a phone call away (use the local toll-free Hilti number).



# FIRESTOP ACRYLIC SEALANT CFS-S ACR

An acrylic based firestop sealant that provides movement capability in fire rated linear joint seals and penetration seals



## APPLICATIONS

- Within or between flexible wall constructions
- Vertical joints in / between wall constructions
- Horizontal joints in a wall abutting a floor, ceiling or roof
- Joints in floor construction
- Penetration seals (steel and copper pipes)

## ADVANTAGES

- Easy to dispense, apply and tool
- Strong adhesion to various base materials
- Low shrinkage after curing
- Excellent airborne sound insulation property
- Broad application temperature range



\* The European Technical Approval (ETA) can be obtained via your local Hilti contact or [www.hilti.com](http://www.hilti.com)

Technical data	CFS-S ACR
Chemical basis	Water-based acrylic dispersion
Volume shrinkage	< 20 %
Movement	12.5% (ISO 11600)
Cure Time (at 23°C/50% r.H.)	~ 3 mm/72 h
Application temperature range	5°C - 40°C
Storage and transportation temperature - range	5°C - 25°C
Shelf life (@73°F/23°C and 50% relative humidity)	24 month(s)
Reaction to fire class	D-s1d0 (EN13501-1)
Approvals*	ETA 10 / 0292, ETA 10 / 0389



Package	Volume	Color	Order designation	Sales Quantity	Item Number
Cartridge	310 ml	white	Firestop acrylic sealant CFS-S ACR	1 pc	435859
Cartridge	310 ml	white	Firestop acrylic sealant CFS-S ACR	1 pc	435860
Cartridge	310 ml	grey	Firestop acrylic sealant CFS-S ACR	1 pc	435862
Foil pack	580 ml	white	Firestop acrylic sealant CFS-S ACR	20 pc	435863
Pail	5 l	white	Firestop acrylic sealant CFS-S ACR	1 pc	435864
Pail	10 l	white	Firestop acrylic sealant CFS-S ACR	1 pc	2046766



Hilti Corporation  
9494 Schaan, Liechtenstein  
P +423-234 2965

[www.facebook.com / hiltigroup](https://www.facebook.com/hiltigroup)  
[www.hilti.group](http://www.hilti.group)