









TECHNICAL MANUAL STRUCTURAL TIMBER SCREWS



TABLE OF CONTENTS

1. Structural timber screws: introduction	4
• Head shapes and thread geometry	4
• Portfolio overview and naming	6
• Corrosion protection information	7
• Structural timber screws portfolio applications overview	10
• Timber screw design software	12
2. Partial threaded structural timber screws	13
PORTFOLIO OVERVIEW, GEOMETRY AND CHARACTERISTIC VALUES	
S-WCP-S Z – Partial threaded screw with 90° countersunk head	13
	
S-WWP-S Z – Partial threaded screw with washer head	17
	
3. Full threaded structural timber screws	21
PORTFOLIO OVERVIEW, GEOMETRY AND CHARACTERISTIC VALUES	
S-WCF-H Z – Full threaded screw with 90° countersunk head	21
	
S-WXF-S Z and S-WXF-H Z – Full threaded screw with cylindric head	27
	
S-WDF-S Z – Full threaded screw with dual head	33
	
S-W LS – Lifting point solution	34
	
4. Additional technical information	35
5. Tools, insert bits and accessories	49
	

1. STRUCTURAL TIMBER SCREWS INTRODUCTION

Head shapes and thread geometry

Head shapes

Features

Product range

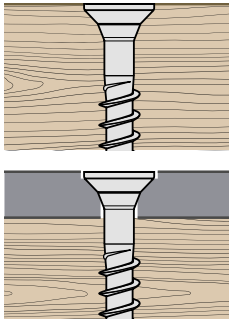

90° countersunk head with milling pockets

- Milling pockets reduce tearing and splitting in the timber structure
- Ideal for metal/timber connections
- Fits perfectly into metal parts

S-WCF-H Z – Full threaded screw with 90° countersunk head
 Ø 8 mm L: 120–580 mm
 Ø 10 mm L: 120–580 mm

S-WCP-S Z – Partial threaded screw with 90° countersunk head
 Ø 5 mm L: 40–100 mm
 Ø 6 mm L: 50–180 mm
 Ø 8 mm L: 80–400 mm
 Ø 10 mm L: 160–400 mm

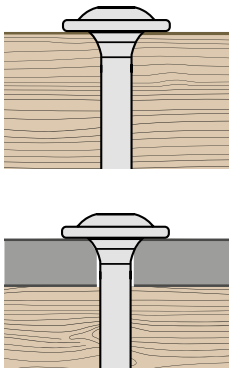

Washer head

- Highest head pull-through resistance values for sturdy joints pulled tightly together
- No washers are required, which makes processing faster

S-WWP-S Z – Partial threaded screw with washer head
 Ø 6 mm L: 60–200 mm
 Ø 8 mm L: 80–580 mm
 Ø 10 mm L: 140–580 mm

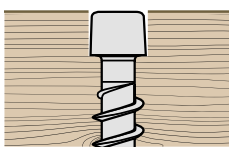

Cylinder head

- Reduced blast effect so that wood surface does not splinter
- Head is able to countersink deep into timber by using a long insert bit

S-WXF-S Z – Full threaded screw with cylindric head (full tip)
 Ø 8 mm L: 120–500 mm

S-WXF-H Z – Full threaded screw with cylindric head (half tip)
 Ø 10 mm L: 200–500 mm

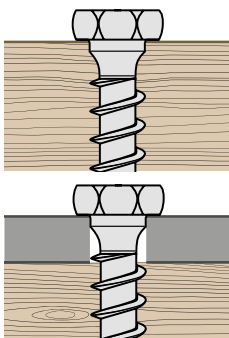

Dual head

- The hexagonal recess allows better force transfer
- Recommended for timber structure with higher density
- Additional TORX® recess saves the time of changing tools

S-WDF-S Z – Full threaded screw with dual head
 Ø 12 mm L: 60–160 mm

Thread types

Partial threaded screw



Straight friction part

- Lower screw-in resistance/ lower torque
- Allows higher battery reach

Hi-Lo thread

- Faster screw-in possible
- Higher load values

Grooved thread

- Reduces blast effect
- Faster screw-in possible



Full thread

- Excellent thread pull-out values
 - Excellent pressure values
 - Maximum load-bearing capacity
-

Tip types



Stitch point tip (full tip)

- Self-drilling tip with compressor
- Saves time by drilling precisely and instantly, even with oblique and end-grain connections
- Less wood splitting and lower screw-in resistance compared to conventional timber construction screws
- No pre-drilling needed (depends on timber type)



Half tip with core fins

- Can be placed significantly closer to the edge & end-grain
 - Less wood splitting
 - No pre-drilling needed
-

Portfolio overview and naming



Material description chart

S - WWP - S - 8x220 100 Z

① ② ③ ④ ⑤ ⑥ ⑦



- ① S
- ② W
- ③ Head type
- ④ Thread type
- ⑤ Tip types
- ⑥ Dimension
- ⑦ Coating/corrosion protection

Screw fastening technology
 Application type:
 structural wood/timber
 C = countersunk head
 W = washer head
 X = cylinder head
 D = dual head (HEX & TORX®)
 F = full threaded
 P = partial threaded
 S = stitch point tip (full tip) 
 H = half tip 
 8 = screw diameter in mm
 220 = screw length in mm
 100 = thread length in mm
 Z = Carbon steel, electro galvanized and passivated with anti-friction coating

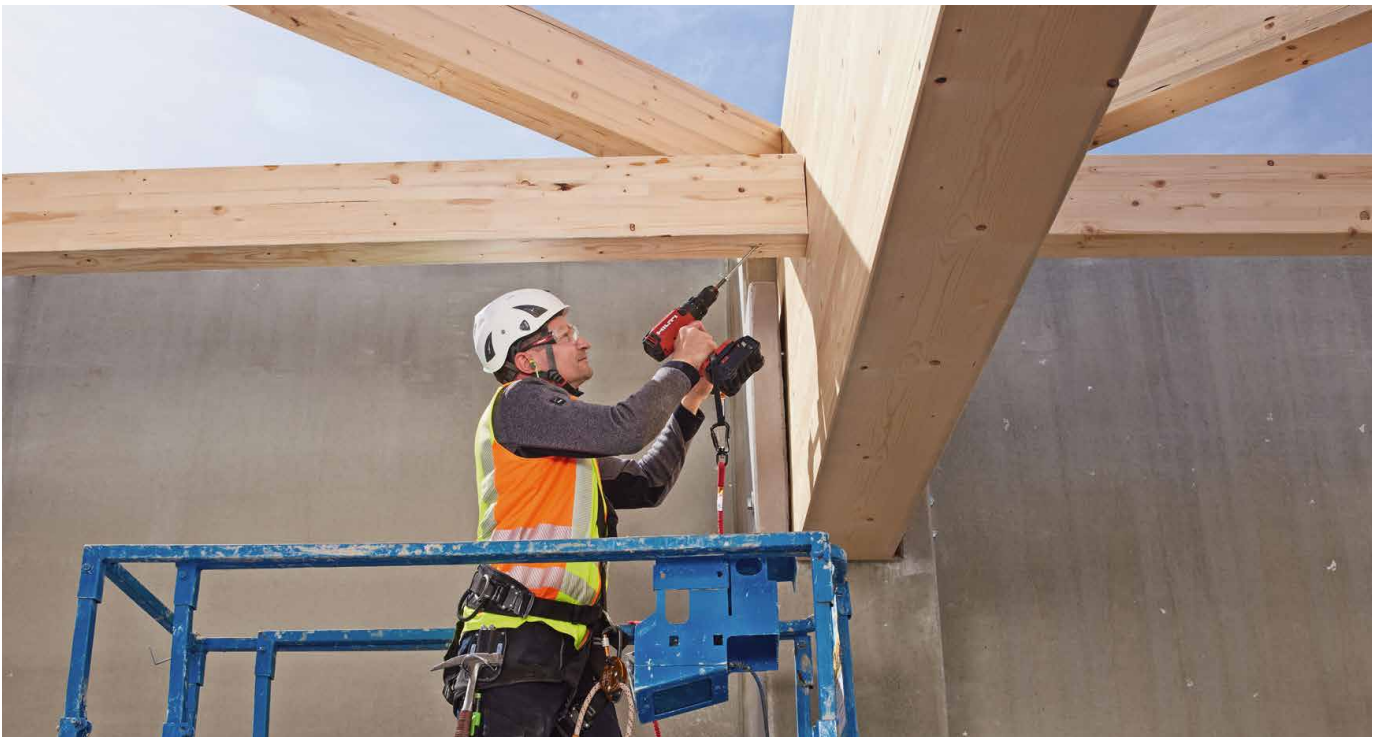

Corrosion protection information

Timber is a versatile building material that has been used to construct durable structures for centuries. Even to aggressive environments, timber is very resistant, so that the use of timber in these areas can be very economical.

Due to their high mechanical strength and ease of processing, timber construction screws are being used more and more frequently compared to classic timber-timber connections. However, metal sometimes reacts very sensitively to chemicals. Some woods contain acids that can cause destruction of the metal fastener. Therefore, when selecting timber construction screws, the type of timber, the timber ingredients from wood preservation or wood treatment (e.g. thermal treatment, acetylated compounds), as well as the climatic ambient conditions must be taken into account.

When using timber construction screws in timber structures, the fastener may be exposed to corrosion in different ways. The external part of the fastener (screw head) is exposed to corrosion from the atmosphere which depends on relative humidity, air pollution, chloride content and if the connection is weathered (exposed to rain) or non-weathered. The corrosion exposure of the part of the timber construction screws screwed into the timber depends on wood species, wood treatment and moisture content. Timber construction screws shall withstand corrosion exposure of both the timber and the atmosphere for the design service life of 50 years.

The minimum requirements for corrosion protection of timber construction screws are regulated in EN 1995-1-1:2004 (EC5), DIN SPEC 1052-100:2013 and EN 14592:2022.

Service classes according to EN 1995-1-1 (EC5)

Due to the physical properties of timber materials, timber structures must be assigned to specific service classes that characterize the atmospheric conditions of the structure's environment during its use (see Table 1).

Service class	Environment climate	Typical environments	Average moisture content
1	20 °C moisture content ≤ 65 %	Interior: dry, heated buildings with clean atmospheres, e.g. offices, shops, schools, hotels Exterior: n/a	5 %–15 %
2	20 °C moisture content ≤ 85 %	Interior: unheated buildings where condensation can occur, e.g. depots, sport halls Exterior: protected outdoor environment and roofed, open structures e.g. halls, storage areas, parking decks which are open to the outside	10 %–20 %
3	Higher moisture contents than in service class 2	Interior: high humidity, e.g. food-processing plants, laundries, breweries, dairies Exterior: directly exposed to external atmosphere, e.g. unprotected outdoor environment, exposed directly to atmosphere, coastal areas	12 %–24 %

Table 1: Overview of the classification of service classes

Service class 1 is characterized by a moisture content in the timber materials corresponding to a temperature of 20° C and the relative humidity of the surrounding air only exceeding 65 % for a few weeks per year, e.g. structures closed on all sides and heated. In service class 1 the average moisture content in most softwoods will not exceed 12 %.

Service class 2 is characterized by a moisture content in the timber materials corresponding to a temperature of 20° C and the relative humidity of the surrounding air only exceeding 85 % for a few weeks per year, e.g. for roofed, open structures. In service class 2 the average moisture content in most softwoods will not exceed 20 %.

Service class 3 is characterized by climate conditions leading to higher moisture contents than in service class 2, e.g. structures directly exposed to external atmosphere and areas with high humidity

In **EN 1995-1-1**, Table 4.1 then defines the minimum requirements for corrosion protection for timber construction screws in the various service classes. For timber construction screws with a nominal diameter > 4 mm, no corrosion protection is required for the use of the screws in service classes 1 and 2.

Fastener	Service Class (see table 1)		
	1	2	3
Nails and screws with $d \leq 4$ mm	None	Fe/Zn 12c	Fe/Zn 12c
Bolts, dowels, nails and screws with $d > 4$ mm	None	None	Fe/Zn 12c

Table 2: Table 4.1 from EN 1995-1-1: Examples of minimum specifications for material protection against corrosion for fasteners (related to ISO 2081)

In Germany, in addition to EN 1995-1-1, the standard DIN SPEC 1052-100 must also be observed. According to DIN SPEC 1052-100, slightly higher zinc coating thickness is required for aggressive environments. Additionally, the environmental exposure is considered to some extent based on the corrosion classes according to ISO 12944-2 (see Hilti corrosion handbook for further information). Table 3 shows the part of DIN 1052-100 relevant for timber construction screws.

	Construction materials, fasteners	Corrosion protection based on DIN EN ISO 2081 or average zinc coating thickness in μm and/or protective measures			
		With moderate corrosion exposure (corrosivity category C3 ^a)		In case of high and very high corrosion load (corrosivity categories C4 and C5 ^a)	
		Service Class 1	Service Class 2	Service Classes 1, 2 and 3 at C4	Service Class 3 at C5
1	Nails and screws with $d \leq 4$ mm	None ^d	Fe/Zn 12c	55	Suitable stainless steel
2	Nails $d > 4$ mm, screws $d > 4$ mm, dowels, bolts, washers, nuts	None ^d	None ^d	55	Suitable stainless steel

^a According to DIN EN ISO 12944-2

^d In case of steel-to-timber connections with external steel plates, nails and screws must have an average zinc coating thickness of at least 7 μm

Table 3: Extract from Table 1, DIN 1052-100: Examples of minimum requirements for the construction materials or corrosion protection of fasteners for moderate, high or very high corrosion loads

In the **EN 14592** the service classes are replaced by timber categories (T) and corrosion classes (C). This approach gives a technically more sophisticated and straightforward way to select the necessary corrosion requirement.

In Chapter 4 and Annex B of EN 14592, it is defined, how to determine the corrosion protection for dowel-type fasteners. Timber construction screws should withstand corrosion exposure of both the timber and the atmosphere for the design service life of 50 years.

Pure zinc coated fasteners shall be assigned to a T-category and C-category. The T-category concerns corrosion caused by the timber and the appropriate category should be determined from Table B.3. Moisture content, treatments applied to the timber, timber species (pH value) and fire retardants influence the corrosion rate.

The C-category refers to the fastener resistance with respect corrosion caused by the atmosphere and the appropriate category should be determined from Table B.1 and Table B.2.

The minimum thickness for pure zinc coating of timber construction screws made of carbon steel can be determined according to Table 1 and Table 2 of EN 14592. For the use of the screws in the timber category T1 and atmosphere category C1 no corrosion protection is required. Electrogalvanized timber construction screws made of carbon steel with a zinc coating thickness of 10 µm can be used in Timber categories T1 and T2 and the atmosphere categories C1 and C2nw. For applications in C2 atmospheres, CrIII passivation may reduce the required coating thickness by 25 %, For applications in the timber categories T3 to T5 and atmosphere categories C2w to C5, carbon steel screws with a higher zinc coating thickness, screws with alternative coatings or stainless steel screws shall be used.

The timber categories T1 to T5 do not correspond directly with the Service Classes in EN 1995-1-1:2004. However, for most climates the annual average moisture content in softwood will not exceed 10 % for heated spaces, so that T1 almost corresponds to Service Class 1 and 16 % for unheated spaces, so that T2 almost corresponds to Service Class 2.







Corrosion protection of Hilti timber construction screws according to ETA-22/0772:



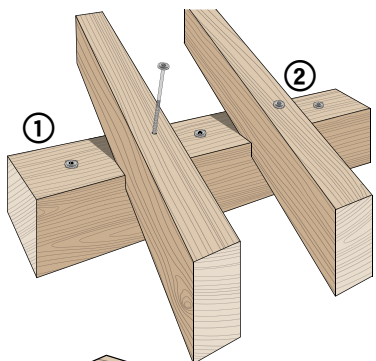
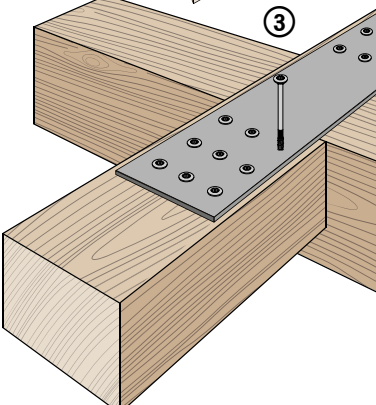

The Hilti self-tapping screws for use in timber constructions according to ETA-22/0772 are made from special carbon steel. They are hardened, electrogalvanized and passivated (CRIII / blue), and anti-friction coated. The corrosion resistance of a Hilti screw can be expressed to T2/C2nw according to the standard EN 14592:2022-04 and exceeds the minimum requirements for corrosion protection of the standards EN 1995-1-1 and DIN SPEC 1052-100.

Hilti screws can be used in all timber species if the annual average moisture content of 16 % is not exceeded. Service classes 1 and 2 can be used according to EN 1995-1-1:2004 in respect of timber category T1 and T2 according to EN 14592:2022. Furthermore, Hilti screws can be used in corrosivity category C1 and C2 (non-weathered) according to EN ISO 9223:2012 or atmosphere category C1 and C2nw according to EN 14592:2022.

Typical indoor and outdoor environmental conditions in which Hilti self-tapping screws can be used are listed in Table 1 (service classes 1 and 2).

Structural timber screws portfolio applications overview

Screw portfolio	Application picture	Application overview	Key features
<div style="display: flex; justify-content: space-around;"> <div style="text-align: center;">  <p>S-WCP-S Z Partial threaded screw with countersunk head</p> </div> <div style="text-align: center;">  <p>S-WWP-S Z Partial threaded screw with washer head</p> </div> </div>	<div style="display: flex; flex-direction: column; align-items: center;">      </div>	<p>Doubling rafters ① S-WCP-S Doubling for reinforcement is usually done on the top or side of the rafter.</p> <p>Rafters ② S-WWP-S Partial thread screws transfer the wind suction load and shear forces to the substructure through the screw heads.</p> <p>Metal sheets and shaped sheet/metal parts to timber S-WWP-S, S-WCP-S ③ screws are optimal for metal sheets and shaped sheet metal parts. These screws have milling pockets that allow them to be optimally centered and to fit perfectly into metal parts.</p> <p>CLT walls and ceilings Cross-Laminated-Timber (CLT) – ceiling panel screwed to the walls with S-WCP-S. Hilti screws are approved for all side-grain and end-grain (0° and 90°) applications as well as CLT wide-face and narrow-face.</p> <p>Corner and wall screw connections are pulled tightly together and securely screwed with S-WWP-S.</p>	<p>S-WWP-S Washer head eliminates the need to use a separate washer. Higher head pull-through values. Significant lower torque requirement for the screw-in process. Straight friction part reduces torque requirement by removing material. Longer battery life for a screwdriver drill.</p> <p>S-WCP-S Countersunk head 90° with milling pockets. Ideal for metal/timber connections. Fits perfectly into metal parts. Partial thread Hi/Low allows a faster screw setting process. The high technical values help to ensure a secure hold even for oblique and end-grain connections.</p>

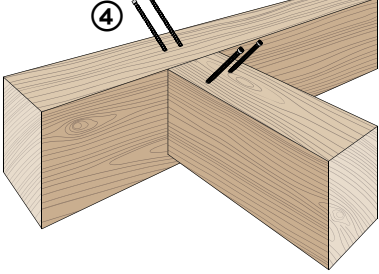
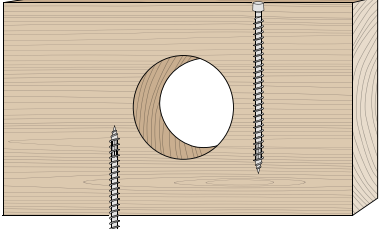
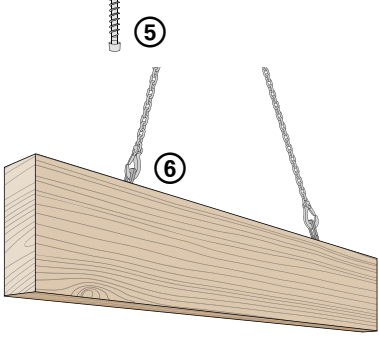
Screw portfolio	Application picture	Application overview	Key features
 <p>S-WCF-H Z Full threaded screw with countersunk head</p> <p>S-WXF-S Z Full threaded screw with cylindric head (full tip)</p>	  	<p>Support reinforcement with steel plate and full-thread screws ① S-WCF-H full-thread screws transfer the support load from the timber section directly to the steel plate through the screw heads. They distribute the force evenly into the end grain of the support.</p> <p>Transverse tension reinforcement for notching ② S-WXF-S and S-WXF-H full-thread screws are used to reinforce and secure the beam in the red line area.</p> <p>Connections at the base point of the support ③ S-WCF-H full-thread screws with a countersunk head are best suited for this application. Shear forces and wind suction are effectively transferred.</p>	<p>S-WCF-H screw with a countersunk head 90° ideal for metal/timber connections. The under-head design fits perfectly into metal parts. The half-tip design ensures that screws > 200 mm penetrate w/o bending. Lower edge distances possible: can achieve down to 3-4 x diameter (depending on timber type and application), typically 5-10 x diameter.</p> <p>S-WXF-S screws help to reduce the wood-splitting effect. The screw head can be penetrated deep into the timber.</p>
 <p>S-WDF-S Z Full threaded screw with dual head</p> <p>S-W LS Lifting system</p>	  	<p>Cross-laminated timber (ceiling rib) ④ S-WXF-S and S-WXF-H are ideal screws for shear-resistant crosswise screwing for cross-laminated timber ceilings.</p> <p>Reinforcement of openings with long full-thread screws ⑤ Long full-thread screws S-WXF-S and S-WF-H with cylinder heads are recommended for the application.</p> <p>S-WDF-S ⑥ screws are used in timber constructions as a lifting system for prefabricated roofs, walls and ceilings, in timber frame construction for the prefab house industry, solid timber boards and cross-laminated timber.</p>	<p>S-WDF-S dual head screws with the HEX (hexagonal) recess provide good force transfer of loads. An additional TX (TORX) drive saves the time of changing tools.</p>

Timber screw design software

- Easy and intuitive to operate - it enables you to calculate structural timber application in less time
- The software takes national regulations into account and offers a multi-language interface
- The software provides the result of the calculations in a PDF-File formatted report



2. PARTIAL THREADED STRUCTURAL TIMBER SCREWS

S-WCP-S Z – Partial threaded screw with 90° countersunk head

- Countersunk head 90° with milling pockets
- Ideal for metal/timber connections. Fits perfectly into metal parts
- Partial thread Hi/Low allows a faster screw setting process
- A secure hold even for oblique and end grain connections

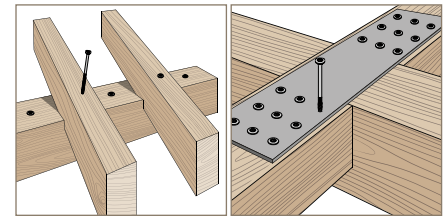

Item name	d [mm]	L [mm]	Thread length b [mm]	Head Ø d _k [mm]	Recess drive	Pcs. per box	Item number
S-WCP-S-5x40/25 Z	5.0	40	25	10	TX25	500	2363555
S-WCP-S-5x50/30 Z		50	30			250	2363556
S-WCP-S-5x60/40 Z		60	40			250	2363557
S-WCP-S-5x70/40 Z		70	40			200	2363558
S-WCP-S-5x80/50 Z		80	50			200	2363559
S-WCP-S-5x90/50 Z		90	50			100	2363620
S-WCP-S-5x100/60 Z		100	60			100	2363621
S-WCP-S-6x50/30 Z	6.0	50	30	12	TX30	250	2363622
S-WCP-S-6x60/40 Z		60	40			200	2363623
S-WCP-S-6x70/40 Z		70	40			200	2363624
S-WCP-S-6x80/50 Z		80	50			100	2363625
S-WCP-S-6x90/50 Z		90	50			100	2363626
S-WCP-S-6x100/60 Z		100	60			100	2363627
S-WCP-S-6x110/60 Z		110	60			100	2363628
S-WCP-S-6x120/70 Z		120	70			100	2363629
S-WCP-S-6x130/70 Z		130	70			100	2363630
S-WCP-S-6x140/70 Z		140	70			100	2363631
S-WCP-S-6x150/70 Z	150	70	100	2363632			
S-WCP-S-6x160/70 Z	160	70	100	2363633			
S-WCP-S-6x180/70 Z	180	70	100	2363634			
S-WCP-S-8x80/50 Z	8.0	80	50	15	TX40	75	2363635
S-WCP-S-8x90/50 Z		90	50			75	2363636
S-WCP-S-8x100/60 Z		100	60			75	2363637
S-WCP-S-8x120/80 Z		120	80			75	2363638
S-WCP-S-8x140/80 Z		140	80			75	2363639
S-WCP-S-8x160/80 Z		160	80			75	2363640
S-WCP-S-8x180/100 Z		180	100			75	2363641
S-WCP-S-8x200/100 Z		200	100			75	2363642
S-WCP-S-8x220/100 Z		220	100			75	2363643
S-WCP-S-8x240/100 Z		240	100			75	2363644
S-WCP-S-8x260/100 Z		260	100			75	2363645
S-WCP-S-8x280/100 Z	280	100	75	2363646			
S-WCP-S-8x300/100 Z	300	100	75	2363647			
S-WCP-S-8x320/100 Z	320	100	75	2363648			
S-WCP-S-8x340/100 Z	340	100	75	2363649			

Item name	d [mm]	L [mm]	Thread length b [mm]	Head Ø d _k [mm]	Recess drive	Pcs. per box	Item number
S-WCP-S-8x360/100 Z	8.0	360	100	15	TX40	75	2363650
S-WCP-S-8x380/100 Z		380	100			75	2363651
S-WCP-S-8x400/100 Z		400	100			75	2363652
S-WCP-S-10x160/80 Z		160	80			50	2363653
S-WCP-S-10x180/100 Z		180	100			50	2363654
S-WCP-S-10x200/100 Z		200	100			50	2363655
S-WCP-S-10x220/100 Z		220	100			50	2363656
S-WCP-S-10x240/100 Z		240	100			50	2363657
S-WCP-S-10x260/100 Z	10	260	100	18.5	TX50	50	2363658
S-WCP-S-10x280/100 Z		280	100			50	2363659
S-WCP-S-10x300/100 Z		300	100			50	2363660
S-WCP-S-10x320/100 Z		320	100			50	2363661
S-WCP-S-10x340/100 Z		340	100			50	2363662
S-WCP-S-10x360/100 Z		360	100			50	2363663
S-WCP-S-10x380/100 Z		380	100			50	2363664
S-WCP-S-10x400/100 Z		400	100			50	2363665

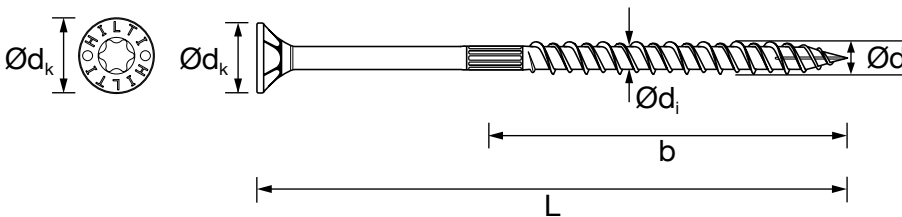

GEOMETRY AND MECHANICAL CHARACTERISTICS for C24 timber

Technical data:

Nominal diameter	d [mm]	Ø5	Ø6	Ø8	Ø10
Head diameter	d _k [mm]	10.0	12.0	15.0	18.5
Shank diameter	d _i [mm]	3.25	4.00	5.35	6.80
Characteristic withdrawal parameter	f _{ax,k,90°} [N/mm ²]	13.6	13.0	10.9	11.0
Characteristic head pull-through parameter	f _{head,k} [N/mm ²]	14.6	14.6	12.4	12.2
Characteristic tensile strength	f _{tens,k} [kN]	8.8	13.1	23.3	35.0
Characteristic yield moment	M _{y,k} [Nmm]	5900	10700	22600	33600

Values for C24 ($\rho_k = 350 \text{ kg/m}^3$), axial axis to grain: 30°–90°, $F_{ax,Rk}$ = thread withdrawal, $F_{head,Rk}$ = head pull through, $F_{V,Rk}$ = shear (// to grain 0°– \perp to grain 90°), timber/steel plate: l_{ef} = thread length b, t_{min} = minimum timber thickness, t_{max} = maximum timber thickness, add-on part (L-b), $F_{V,Rk,thin}$ = steel sheet $t \leq d/2$, $F_{V,Rk,thick}$ = steel sheet $t \geq d$

Type and printing errors reserved. The values stated are meant to serve as planning guides; projects should only be undertaken by authorized professionals.

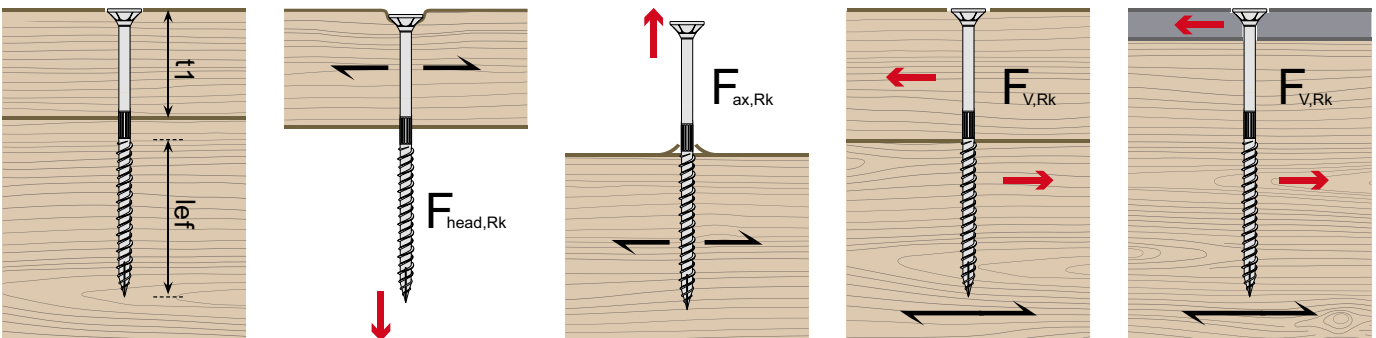

S-WCP-S Z – Partial threaded screw with 90° countersunk head: loads



Thread type – Partial threaded – Friction part – Hi/Low

Diameter Ø 5 mm			Tension		Shear			Item no.
			Head pull-through	Thread withdrawal	Timber to timber	Steel to timber		
Description	L/b [mm]	t _{1,min} [mm]	F _{head,Rk} [kN]	F _{ax,Rk} [kN]	F _{v,Rk} [kN]	F _{v,Rk,thin} [kN]	F _{v,Rk,thick} [kN]	
S-WCP-S-5x40/25 Z	40/25	–	1.46	1.70	–	1.24	1.94	2363555
S-WCP-S-5x50/30 Z	50/30	–	1.46	2.04	–	1.59	2.17	2363556
S-WCP-S-5x60/40 Z	60/40	–	1.46	2.72	–	1.86	2.34	2363557
S-WCP-S-5x70/40 Z	70/40	30	1.46	2.72	1.49	1.86	2.34	2363558
S-WCP-S-5x80/50 Z	80/50	30	1.46	3.40	1.49	2.03	2.51	2363559
S-WCP-S-5x90/50 Z	90/50	40	1.46	3.40	1.54	2.03	2.51	2363620
S-WCP-S-5x100/60 Z	100/60	40	1.46	4.08	1.54	2.20	2.68	2363621

Diameter Ø 6 mm			Tension		Shear			Item no.
			Head pull-through	Thread withdrawal	Timber to timber	Steel to timber		
Description	L/b [mm]	t _{1,min} [mm]	F _{head,Rk} [kN]	F _{ax,Rk} [kN]	F _{v,Rk} [kN]	F _{v,Rk,thin} [kN]	F _{v,Rk,thick} [kN]	
S-WCP-S-6x50/30 Z	50/30	–	2.10	2.34	–	1.77	2.75	2363622
S-WCP-S-6x60/40 Z	60/40	–	2.10	3.12	–	2.17	3.17	2363623
S-WCP-S-6x70/40 Z	70/40	30	2.10	3.12	1.93	2.47	3.17	2363624
S-WCP-S-6x80/50 Z	80/50	30	2.10	3.90	1.93	2.66	3.36	2363625
S-WCP-S-6x90/50 Z	90/50	40	2.10	3.90	2.20	2.66	3.36	2363626
S-WCP-S-6x100/60 Z	100/60	40	2.10	4.68	2.20	2.86	3.56	2363627
S-WCP-S-6x110/60 Z	110/60	50	2.10	4.68	2.21	2.86	3.56	2363628
S-WCP-S-6x120/70 Z	120/70	50	2.10	5.46	2.21	3.05	3.75	2363629
S-WCP-S-6x130/70 Z	130/70	50	2.10	5.46	2.21	3.05	3.75	2363630
S-WCP-S-6x140/70 Z	140/70	50	2.10	5.46	2.21	3.05	3.75	2363631
S-WCP-S-6x150/70 Z	150/70	50	2.10	5.46	2.21	3.05	3.75	2363632
S-WCP-S-6x160/70 Z	160/70	50	2.10	5.46	2.21	3.05	3.75	2363633
S-WCP-S-6x180/70 Z	180/70	50	2.10	5.46	2.21	3.05	3.75	2363634

S-WCP-S Z – Partial threaded screw with 90° countersunk head: loads



Thread type – Partial threaded – Friction part – Hi/Low

Diameter Ø 8 mm			Tension		Shear			Item no.
			Head pull-through	Thread withdrawal	Timber to timber	Steel to timber		
Description	L/b [mm]	t _{1,min} [mm]	F _{head,Rk} [kN]	F _{ax,Rk} [kN]	F _{v,Rk} [kN]	F _{v,Rk,thin} [kN]	F _{v,Rk,thick} [kN]	
S-WCP-S-8x80/50 Z	80/50	30	2.79	4.36	2.69	3.54	4.93	2363635
S-WCP-S-8x90/50 Z	90/50	40	2.79	4.36	2.97	3.80	4.93	2363636
S-WCP-S-8x100/60 Z	100/60	40	2.79	5.23	2.97	4.02	5.14	2363637
S-WCP-S-8x120/80 Z	120/80	40	2.79	6.98	2.97	4.46	5.58	2363638
S-WCP-S-8x140/80 Z	140/80	60	2.79	6.98	3.41	4.46	5.58	2363639
S-WCP-S-8x160/80 Z	160/80	60	2.79	6.98	3.41	4.46	5.58	2363640
S-WCP-S-8x180/100 Z	180/100	60	2.79	8.72	3.41	4.89	6.02	2363641
S-WCP-S-8x200/100 Z	200/100	60	2.79	8.72	3.41	4.89	6.02	2363642
S-WCP-S-8x220/100 Z	220/100	60	2.79	8.72	3.41	4.89	6.02	2363643
S-WCP-S-8x240/100 Z	240/100	60	2.79	8.72	3.41	4.89	6.02	2363644
S-WCP-S-8x260/100 Z	260/100	60	2.79	8.72	3.41	4.89	6.02	2363645
S-WCP-S-8x280/100 Z	280/100	60	2.79	8.72	3.41	4.89	6.02	2363646
S-WCP-S-8x300/100 Z	300/100	60	2.79	8.72	3.41	4.89	6.02	2363647
S-WCP-S-8x320/100 Z	320/100	60	2.79	8.72	3.41	4.89	6.02	2363648
S-WCP-S-8x340/100 Z	340/100	60	2.79	8.72	3.41	4.89	6.02	2363649
S-WCP-S-8x360/100 Z	360/100	60	2.79	8.72	3.41	4.89	6.02	2363650
S-WCP-S-8x380/100 Z	380/100	60	2.79	8.72	3.41	4.89	6.02	2363651
S-WCP-S-8x400/100 Z	400/100	60	2.79	8.72	3.41	4.89	6.02	2363652

Diameter Ø 10 mm			Tension		Shear			Item no.
			Head pull-through	Thread withdrawal	Timber to timber	Steel to timber		
Description	L/b [mm]	t _{1,min} [mm]	F _{head,Rk} [kN]	F _{ax,Rk} [kN]	F _{v,Rk} [kN]	F _{v,Rk,thin} [kN]	F _{v,Rk,thick} [kN]	
S-WCP-S-10x160/80 Z	160/80	60	4.18	8.80	4.62	5.78	7.26	2363653
S-WCP-S-10x180/100 Z	180/100	60	4.18	11.00	4.62	6.33	7.81	2363654
S-WCP-S-10x200/100 Z	200/100	60	4.18	11.00	4.62	6.33	7.81	2363655
S-WCP-S-10x220/100 Z	220/100	60	4.18	11.00	4.62	6.33	7.81	2363656
S-WCP-S-10x240/100 Z	240/100	60	4.18	11.00	4.62	6.33	7.81	2363657
S-WCP-S-10x260/100 Z	260/100	60	4.18	11.00	4.62	6.33	7.81	2363658
S-WCP-S-10x280/100 Z	280/100	60	4.18	11.00	4.62	6.33	7.81	2363659
S-WCP-S-10x300/100 Z	300/100	60	4.18	11.00	4.62	6.33	7.81	2363660
S-WCP-S-10x320/100 Z	320/100	60	4.18	11.00	4.62	6.33	7.81	2363661
S-WCP-S-10x340/100 Z	340/100	60	4.18	11.00	4.62	6.33	7.81	2363662
S-WCP-S-10x360/100 Z	360/100	60	4.18	11.00	4.62	6.33	7.81	2363663
S-WCP-S-10x380/100 Z	380/100	60	4.18	11.00	4.62	6.33	7.81	2363664
S-WCP-S-10x400/100 Z	400/100	60	4.18	11.00	4.62	6.33	7.81	2363665

S-WWP-S Z – Partial threaded screw with washer head

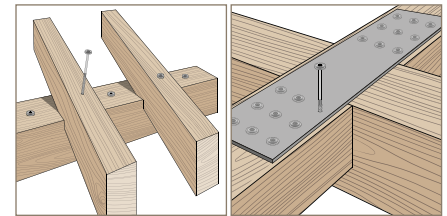

- Washer head eliminates the need to use a separate washer
- Higher head pull-through values
- Straight friction part reduces torque requirement by removing material

Item name	d [mm]	L [mm]	Thread length b [mm]	Head Ø d _k [mm]	Recess drive	Pcs. per box	Item number
S-WWP-S-6x60/40 Z	6.0	60	40	14	TX 30	100	2363516
S-WWP-S-6x80/50 Z		80	50			100	2363517
S-WWP-S-6x100/60 Z		100	60			100	2363518
S-WWP-S-6x120/70 Z		120	70			100	2363519
S-WWP-S-6x140/70 Z		140	70			100	2363520
S-WWP-S-6x160/70 Z		160	70			50	2363521
S-WWP-S-6x180/70 Z		180	70			50	2363522
S-WWP-S-6x200/70 Z		200	70			50	2363523
S-WWP-S-8x80/50 Z		8.0	80			50	20
S-WWP-S-8x100/60 Z	100		60	50	2363525		
S-WWP-S-8x120/80 Z	120		80	50	2363526		
S-WWP-S-8x140/80 Z	140		80	50	2363527		
S-WWP-S-8x160/80 Z	160		80	50	2363528		
S-WWP-S-8x180/100 Z	180		100	50	2363529		
S-WWP-S-8x200/100 Z	200		100	50	2363530		
S-WWP-S-8x220/100 Z	220		100	50	2363531		
S-WWP-S-8x240/100 Z	240		100	50	2363532		
S-WWP-S-8x260/100 Z	260		100	50	2363533		
S-WWP-S-8x280/100 Z	280		100	50	2363534		
S-WWP-S-8x300/100 Z	300		100	50	2363535		
S-WWP-S-8x320/100 Z	320		100	50	2363536		
S-WWP-S-8x340/100 Z	340		100	50	2363537		
S-WWP-S-8x360/100 Z	360		100	50	2363538		
S-WWP-S-8x380/100 Z	380		100	50	2363539		
S-WWP-S-8x400/100 Z	400		100	50	2363540		
S-WWP-S-8x500/100 Z	500	100	50	2372406			
S-WWP-S-8x580/100 Z	580	100	25	2372407			
S-WWP-S-10x140/80 Z	10	140	80	25	TX 50	25	2363541
S-WWP-S-10x160/80 Z		160	80			25	2363542
S-WWP-S-10x180/100 Z		180	100			25	2363543
S-WWP-S-10x200/100 Z		200	100			25	2363544
S-WWP-S-10x220/100 Z		220	100			25	2363545
S-WWP-S-10x240/100 Z		240	100			25	2363546
S-WWP-S-10x260/100 Z		260	100			25	2363547
S-WWP-S-10x280/100 Z		280	100			25	2363548

Item name	d [mm]	L [mm]	Thread length b [mm]	Head Ø d _k [mm]	Recess drive	Pcs. per box	Item number
S-WWP-S-10x300/100 Z	10	300	100	25	TX 50	25	2363549
S-WWP-S-10x320/100 Z		320	100			25	2363550
S-WWP-S-10x340/100 Z		340	100			25	2363551
S-WWP-S-10x360/100 Z		360	100			25	2363552
S-WWP-S-10x380/100 Z		380	100			25	2363553
S-WWP-S-10x400/100 Z		400	100			25	2363554
S-WWP-S-10x500/100 Z		500	100			25	2372408
S-WWP-S-10x580/100 Z		580	100			25	2372409

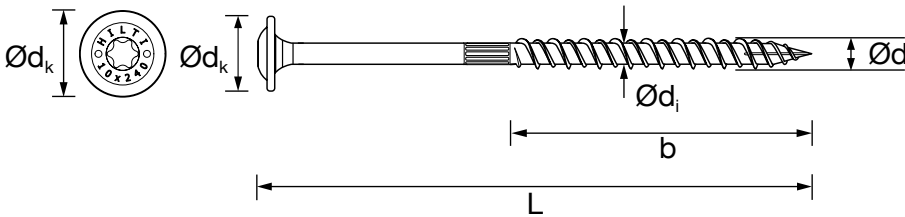

GEOMETRY AND MECHANICAL CHARACTERISTICS for C24 timber

Technical data:

Nominal diameter	d [mm]	Ø6	Ø8	Ø10
Head diameter	d _k [mm]	14.0	20.0	25.0
Shank diameter	d _i [mm]	4.00	5.35	6.80
Characteristic withdrawal parameter	f _{ax,k,90°} [N/mm ²]	13.0	10.9	11.0
Characteristic head pull-through parameter	f _{head,k} [N/mm ²]	16.7	17.6	15.2
Characteristic tensile strength	f _{tens,k} [kN]	13.1	23.3	35.0
Characteristic yield moment	M _{y,k} [Nmm]	10 700	22 600	33 600

Values for C24 ($\rho_k = 350 \text{ kg/m}^3$), axial axis to grain: 30°–90°, $F_{ax,Rk}$ = thread withdrawal, $F_{head,Rk}$ = head pull through, $F_{v,Rk}$ = shear (// to grain 0°– \perp to grain 90°), timber/steel plate: l_{ef} = thread length b, t_1 min = minimum timber thickness, t_1 max = maximum timber thickness, add-on part (L-b), $F_{v,Rk,thin}$ = steel sheet $t \leq d/2$, $F_{v,Rk,thick}$ = steel sheet $t \geq d$

Type and printing errors reserved. The values stated are meant to serve as planning guides; projects should only be undertaken by authorized professionals.

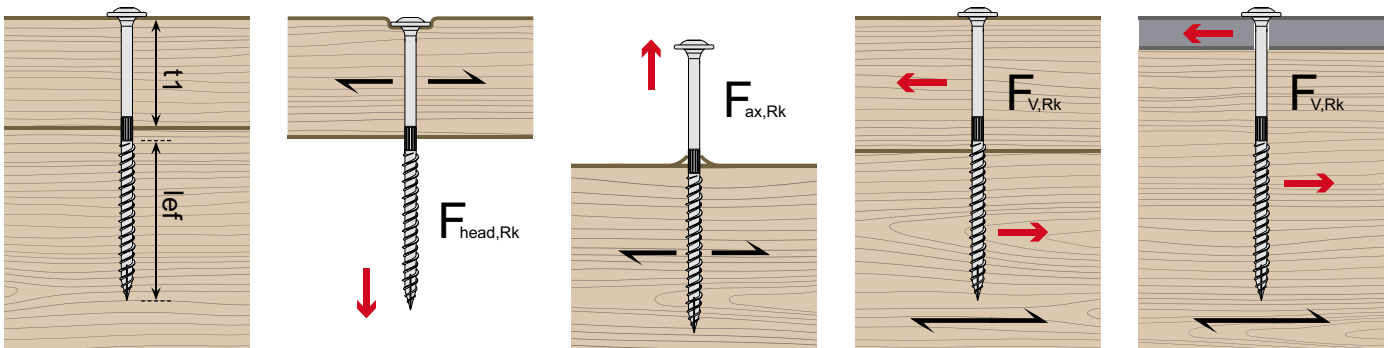

S-WWP-S Z – Partial threaded screw with washer head: loads



Thread type – Partial thread – Friction part – Hi/Low

Diameter Ø 6 mm			Tension		Shear			Item no.
			Head pull-through	Thread withdrawal	Timber to timber	Steel to timber		
Description	L/b [mm]	t _{1,min} [mm]	F _{head,Rk} [kN]	F _{ax,Rk} [kN]	F _{v,Rk} [kN]	F _{v,Rk,thin} [kN]	F _{v,Rk,thick} [kN]	
S-WWP-S-6x60/40 Z	60/40	–	3.27	3.12	–	2.17	3.17	2363516
S-WWP-S-6x80/50 Z	80/50	30	3.27	3.90	2.22	2.66	3.36	2363517
S-WWP-S-6x100/60 Z	100/60	40	3.27	4.68	2.49	2.86	3.56	2363518
S-WWP-S-6x120/70 Z	120/70	50	3.27	5.46	2.51	3.05	3.75	2363519
S-WWP-S-6x140/70 Z	140/70	50	3.27	5.46	2.51	3.05	3.75	2363520
S-WWP-S-6x160/70 Z	160/70	50	3.27	5.46	2.51	3.05	3.75	2363521
S-WWP-S-6x180/70 Z	180/70	50	3.27	5.46	2.51	3.05	3.75	2363522
S-WWP-S-6x200/70 Z	200/70	50	3.27	5.46	2.51	3.05	3.75	2363523

Diameter Ø 8 mm			Tension		Shear			Item no.
			Head pull-through	Thread withdrawal	Timber to timber	Steel to timber		
Description	L/b [mm]	t _{1,min} [mm]	F _{head,Rk} [kN]	F _{ax,Rk} [kN]	F _{v,Rk} [kN]	F _{v,Rk,thin} [kN]	F _{v,Rk,thick} [kN]	
S-WWP-S-8x80/50 Z	80/50	30	7.04	4.36	3.08	3.54	4.93	2363524
S-WWP-S-8x100/60 Z	100/60	40	7.04	5.23	3.58	4.02	5.14	2363525
S-WWP-S-8x120/80 Z	120/80	40	7.04	6.98	4.02	4.46	5.58	2363526
S-WWP-S-8x140/80 Z	140/80	60	7.04	6.98	4.46	4.46	5.58	2363527
S-WWP-S-8x160/80 Z	160/80	60	7.04	6.98	4.46	4.46	5.58	2363528
S-WWP-S-8x180/100 Z	180/100	60	7.04	8.72	4.47	4.89	6.02	2363529
S-WWP-S-8x200/100 Z	200/100	60	7.04	8.72	4.47	4.89	6.02	2363530
S-WWP-S-8x220/100 Z	220/100	60	7.04	8.72	4.47	4.89	6.02	2363531
S-WWP-S-8x240/100 Z	240/100	60	7.04	8.72	4.47	4.89	6.02	2363532
S-WWP-S-8x260/100 Z	260/100	60	7.04	8.72	4.47	4.89	6.02	2363533
S-WWP-S-8x280/100 Z	280/100	60	7.04	8.72	4.47	4.89	6.02	2363534
S-WWP-S-8x300/100 Z	300/100	60	7.04	8.72	4.47	4.89	6.02	2363535
S-WWP-S-8x320/100 Z	320/100	60	7.04	8.72	4.47	4.89	6.02	2363536
S-WWP-S-8x340/100 Z	340/100	60	7.04	8.72	4.47	4.89	6.02	2363537
S-WWP-S-8x360/100 Z	360/100	60	7.04	8.72	4.47	4.89	6.02	2363538
S-WWP-S-8x380/100 Z	380/100	60	7.04	8.72	4.47	4.89	6.02	2363539
S-WWP-S-8x400/100 Z	400/100	60	7.04	8.72	4.47	4.89	6.02	2363540
S-WWP-S-8x500/100 Z	500/100	60	7.04	8.72	4.47	4.89	6.02	2372406
S-WWP-S-8x580/100 Z	580/100	60	7.04	8.72	4.47	4.89	6.02	2372407

S-WWP-S Z – Partial threaded screw with washer head: loads



Thread type – Partial thread – Friction part – Hi/Low

Diameter Ø 10 mm			Tension		Shear			Item no.
			Head pull-through	Thread withdrawal	Timber to timber	Steel to timber		
Description	L/b [mm]	t _{1,min} [mm]	F _{head,Rk} [kN]	F _{ax,Rk} [kN]	F _{v,Rk} [kN]	F _{v,Rk,thin} [kN]	F _{v,Rk,thick} [kN]	
S-WWP-S-10x140/80 Z	140/80	60	9.50	8.80	5.78	5.78	7.26	2363541
S-WWP-S-10x160/80 Z	160/80	60	9.50	8.80	5.78	5.78	7.26	2363542
S-WWP-S-10x180/100 Z	180/100	60	9.50	11.00	5.95	6.33	7.81	2363543
S-WWP-S-10x200/100 Z	200/100	60	9.50	11.00	5.95	6.33	7.81	2363544
S-WWP-S-10x220/100 Z	220/100	60	9.50	11.00	5.95	6.33	7.81	2363545
S-WWP-S-10x240/100 Z	240/100	60	9.50	11.00	5.95	6.33	7.81	2363546
S-WWP-S-10x260/100 Z	260/100	60	9.50	11.00	5.95	6.33	7.81	2363547
S-WWP-S-10x280/100 Z	280/100	60	9.50	11.00	5.95	6.33	7.81	2363548
S-WWP-S-10x300/100 Z	300/100	60	9.50	11.00	5.95	6.33	7.81	2363549
S-WWP-S-10x320/100 Z	320/100	60	9.50	11.00	5.95	6.33	7.81	2363550
S-WWP-S-10x340/100 Z	340/100	60	9.50	11.00	5.95	6.33	7.81	2363551
S-WWP-S-10x360/100 Z	360/100	60	9.50	11.00	5.95	6.33	7.81	2363552
S-WWP-S-10x380/100 Z	380/100	60	9.50	11.00	5.95	6.33	7.81	2363553
S-WWP-S-10x400/100 Z	400/100	60	9.50	11.00	5.95	6.33	7.81	2363554
S-WWP-S-10x500/100 Z	500/100	60	9.50	11.00	5.95	6.33	7.81	2372408
S-WWP-S-10x580/100 Z	580/100	60	9.50	11.00	5.95	6.33	7.81	2372409

3. FULL THREADED STRUCTURAL TIMBER SCREWS

S-WCF-H Z – Full threaded screw with countersunk head



- Ideal for metal/timber connections. The under-head design fits perfectly in metal parts
- The half-tip design ensures that screws > 200 mm penetrate without bending
- Lower edge distances possible: can achieve down to 3-4 x diameter (depending on timber type and application), typically 5-10 x diameter

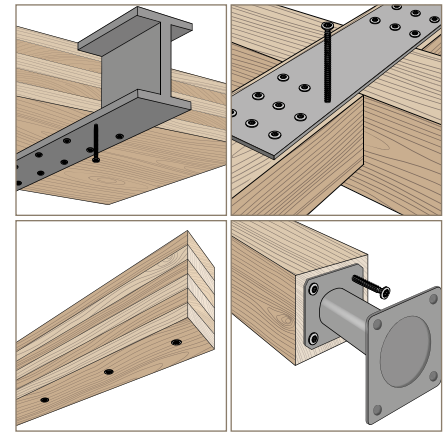

Item name	d [mm]	L [mm]	Thread length b [mm]	Head Ø d _k [mm]	Recess drive	Pcs. per box	Item number
S-WCF-H-8x120 Z	8.0	120	110	15	TX 40	50	2363490
S-WCF-H-8x140 Z		140	130			50	2363491
S-WCF-H-8x160 Z		160	150			50	2363492
S-WCF-H-8x180 Z		180	170			50	2363493
S-WCF-H-8x200 Z		200	190			50	2363494
S-WCF-H-8x220 Z		220	210			50	2363495
S-WCF-H-8x240 Z		240	230			50	2363496
S-WCF-H-8x260 Z		260	250			50	2363497
S-WCF-H-8x280 Z		280	270			50	2363498
S-WCF-H-8x300 Z		300	290			50	2363499
S-WCF-H-8x325 Z		325	315			50	2363580
S-WCF-H-8x350 Z		350	340			50	2363581
S-WCF-H-8x375 Z		375	365			50	2363582
S-WCF-H-8x400 Z		400	390			50	2363583
S-WCF-H-8x450 Z		450	427			25	2363584
S-WCF-H-8x500 Z	500	477	25	2363585			
S-WCF-H-8x580 Z	580	577	25	2372405			
S-WCF-H-10x120 Z	10	120	108	18.5	TX 50	50	2363586
S-WCF-H-10x160 Z		160	148			50	2363587
S-WCF-H-10x180 Z		180	168			50	2363588
S-WCF-H-10x200 Z		200	188			50	2363589
S-WCF-H-10x220 Z		220	208			50	2363590
S-WCF-H-10x240 Z		240	228			50	2363591
S-WCF-H-10x260 Z		260	248			50	2363592
S-WCF-H-10x280 Z		280	268			50	2363593
S-WCF-H-10x300 Z		300	288			50	2363594
S-WCF-H-10x325 Z		325	301			50	2363595
S-WCF-H-10x350 Z		350	326			50	2363596
S-WCF-H-10x375 Z		375	351			50	2363597
S-WCF-H-10x400 Z		400	376			50	2363598
S-WCF-H-10x450 Z		450	426			25	2363599
S-WCF-H-10x500 Z		500	476			25	2363600
S-WCF-H-10x580 Z	580	576	25	2372404			

S-WCF-H Z – Full threaded screw with countersunk head

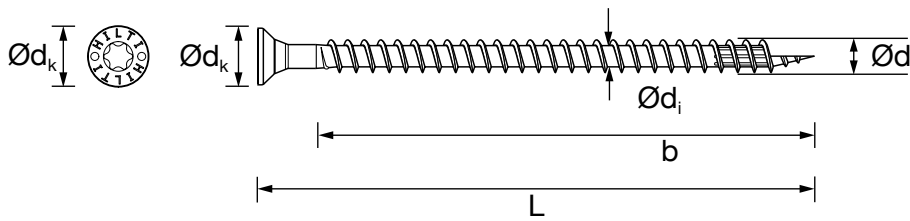

GEOMETRY AND MECHANICAL CHARACTERISTICS for C24 timber

Technical data:

Nominal diameter	d [mm]	Ø8	Ø10
Head diameter	d _k [mm]	15.0	18.5
Shank diameter	d _i [mm]	5.1	6.3
Characteristic withdrawal parameter	f _{ax,k,90°} [N/mm ²]	13.1	12.5
Characteristic head pull-through parameter	f _{head,k} [N/mm ²]	12.4	12.2
Characteristic tensile strength	f _{tens,k} [kN]	24.1	40.0
Characteristic yield moment	M _{y,k} [Nmm]	20 300	36 700
Characteristic buckling capacity	N _{pl,k · kc(*)} [kN]	12.2	18.9

*) total screw length in timber

Values for C24, axial axis to grain: 30°–90°, F_{ax,Rk} = thread withdrawal, F_{head,Rk} = head pull through, F_{v,Rk} = shear (// to grain 0°–⊥ to grain 90°), timber/steel plate: l_{ef} = thread length b, t₁ min = minimum timber thickness, t₁ max = maximum timber thickness, add-on part (L-b), F_{v,Rk,thin} = steel sheet t ≤ d/2, F_{v,Rk,thick} = steel sheet t ≥ d

Type and printing errors reserved. The values stated are meant to serve as planning guides; projects should only be undertaken by authorized professionals.

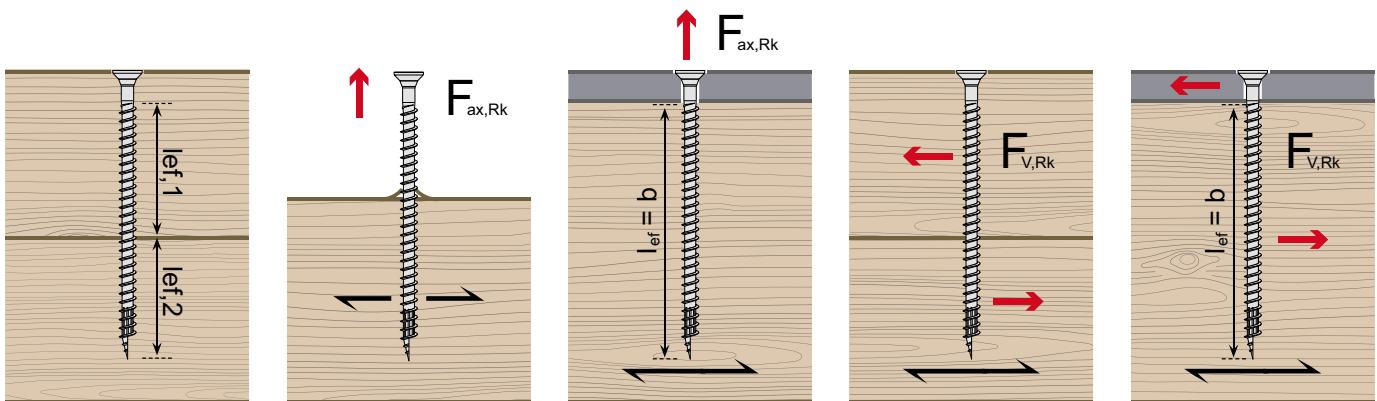

S-WCF-H Z – Full threaded screw with countersunk head: loads



Thread type – Full threaded

Diameter Ø 8 mm		Axial 90°		Shear 90°			Item no.
		Timber to timber $l_{ef} = b/2$	Metal to timber $l_{ef} = b$	Timber to timber $l_{ef} = b/2$	Metal to timber $l_{ef} = b$		
Description	L/b [mm]	$F_{ax,Rk}$ [kN]	$F_{ax,Rk}$ [kN]	$F_{v,Rk}$ [kN]	$F_{v,Rk,thin}$ [kN]	$F_{v,Rk,thick}$ [kN]	
S-WCF-H-8x120 Z	120/110	5.76	11.53	4.01	5.14	6.52	2363490
S-WCF-H-8x140 Z	140/130	6.81	13.62	4.27	5.14	7.04	2363491
S-WCF-H-8x160 Z	160/150	7.86	15.72	4.54	5.14	7.27	2363492
S-WCF-H-8x180 Z	180/170	8.91	17.82	4.80	5.14	7.27	2363493
S-WCF-H-8x200 Z	200/190	9.96	19.91	5.06	5.14	7.27	2363494
S-WCF-H-8x220 Z	220/210	11.00	22.01	5.14	5.14	7.27	2363495
S-WCF-H-8x240 Z	240/230	12.05	24.10	5.14	5.14	7.27	2363496
S-WCF-H-8x260 Z	260/250	13.10	24.10	5.14	5.14	7.27	2363497
S-WCF-H-8x280 Z	280/270	14.15	24.10	5.14	5.14	7.27	2363498
S-WCF-H-8x300 Z	300/290	15.20	24.10	5.14	5.14	7.27	2363499
S-WCF-H-8x325 Z	325/315	16.51	24.10	5.14	5.14	7.27	2363580
S-WCF-H-8x350 Z	350/340	17.82	24.10	5.14	5.14	7.27	2363581
S-WCF-H-8x375 Z	375/365	19.13	24.10	5.14	5.14	7.27	2363582
S-WCF-H-8x400 Z	400/390	20.44	24.10	5.14	5.14	7.27	2363583
S-WCF-H-8x450 Z	450/427	22.37	24.10	5.14	5.14	7.27	2363584
S-WCF-H-8x500 Z	500/477	24.10	24.10	5.14	5.14	7.27	2363585
S-WCF-H-8x580 Z	580/577	24.10	24.10	5.14	5.14	7.27	2372405

S-WCF-H Z – Full threaded screw with countersunk head: loads



Thread type – Full threaded

Diameter Ø 10 mm		Axial 90°		Shear 90°			Item no.
		Timber to timber $l_{ef} = b/2$	Metal to timber $l_{ef} = b$	Timber to timber $l_{ef} = b/2$	Metal to timber $l_{ef} = b$		
Description	L/b [mm]	$F_{ax,Rk}$ [kN]	$F_{ax,Rk}$ [kN]	$F_{v,Rk}$ [kN]	$F_{v,Rk,thin}$ [kN]	$F_{v,Rk,thick}$ [kN]	
S-WCF-H-10x120 Z	120/108	6.75	13.50	5.08	6.33	8.66	2363586
S-WCF-H-10x160 Z	160/148	9.25	18.50	6.05	7.47	9.91	2363587
S-WCF-H-10x180 Z	180/168	10.50	21.00	6.36	7.47	10.53	2363588
S-WCF-H-10x200 Z	200/188	11.75	23.50	6.67	7.47	10.57	2363589
S-WCF-H-10x220 Z	220/208	13.00	26.00	6.99	7.47	10.57	2363590
S-WCF-H-10x240 Z	240/228	14.25	28.50	7.30	7.47	10.57	2363591
S-WCF-H-10x260 Z	260/248	15.50	31.00	7.47	7.47	10.57	2363592
S-WCF-H-10x280 Z	280/268	16.75	33.50	7.47	7.47	10.57	2363593
S-WCF-H-10x300 Z	300/288	18.00	36.00	7.47	7.47	10.57	2363594
S-WCF-H-10x325 Z	325/301	18.81	37.63	7.47	7.47	10.57	2363595
S-WCF-H-10x350 Z	350/326	20.38	40.00	7.47	7.47	10.57	2363596
S-WCF-H-10x375 Z	375/351	21.94	40.00	7.47	7.47	10.57	2363597
S-WCF-H-10x400 Z	400/376	23.50	40.00	7.47	7.47	10.57	2363598
S-WCF-H-10x450 Z	450/426	26.63	40.00	7.47	7.47	10.57	2363599
S-WCF-H-10x500 Z	500/476	29.75	40.00	7.47	7.47	10.57	2363600
S-WCF-H-10x580 Z	580/576	36.00	40.00	7.47	7.47	10.57	2372404

S-WCF-H Z – Full threaded screw with countersunk head: 45° loads



Thread type – Full threaded

Diameter Ø 8 mm		Axial 45°			Shear 45°		Item no.
		Cross-type screw fitting $l_{ef} = b/2$			Timber to timber $l_{ef} = b/2$	Metal to timber $l_{ef} = b$	
Description	L/b [mm]	$F_{v,X1,Rk}$ [kN]	$F_{v,X2,Rk}$ [kN]	$F_{v,X3,Rk}$ [kN]	$F_{v,Rk}$ [kN]	$F_{v,Rk}$ [kN]	
S-WCF-H-8x120 Z	120/110	8.15	14.67	22.01	5.09	10.19	2363490
S-WCF-H-8x140 Z	140/130	9.63	17.34	26.01	6.02	12.04	2363491
S-WCF-H-8x160 Z	160/150	11.12	20.01	30.01	6.95	13.89	2363492
S-WCF-H-8x180 Z	180/170	12.60	22.68	34.01	7.87	15.75	2363493
S-WCF-H-8x200 Z	200/190	14.08	25.34	38.02	8.80	17.60	2363494
S-WCF-H-8x220 Z	220/210	15.56	28.01	42.02	9.73	19.45	2363495
S-WCF-H-8x240 Z	240/230	16.58	29.84	44.76	10.65	21.30	2363496
S-WCF-H-8x260 Z	260/250	17.32	31.17	46.76	11.58	21.30	2363497
S-WCF-H-8x280 Z	280/270	18.06	32.51	48.76	12.51	21.30	2363498
S-WCF-H-8x300 Z	300/290	18.80	33.84	50.76	13.43	21.30	2363499
S-WCF-H-8x325 Z	325/315	19.73	35.51	53.26	14.59	21.30	2363580
S-WCF-H-8x350 Z	350/340	20.65	37.18	55.76	15.75	21.30	2363581
S-WCF-H-8x375 Z	375/365	21.58	38.84	58.26	16.91	21.30	2363582
S-WCF-H-8x400 Z	400/390	22.51	40.51	60.77	18.06	21.30	2363583
S-WCF-H-8x450 Z	450/427	23.88	42.98	64.47	19.78	21.30	2363584
S-WCF-H-8x500 Z	500/477	25.10	45.17	67.76	21.30	21.30	2363585
S-WCF-H-8x580 Z	580/577	25.10	45.17	67.76	21.30	21.30	2372405

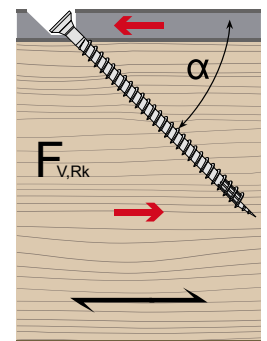
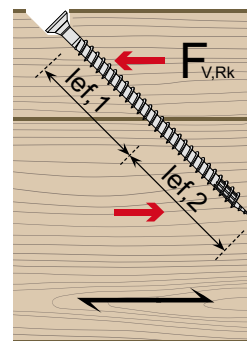
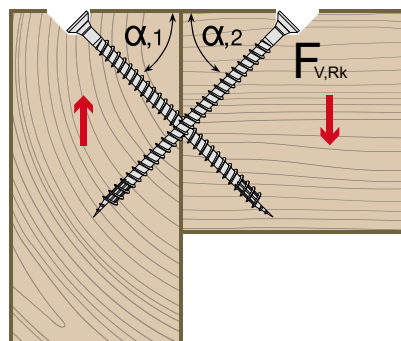
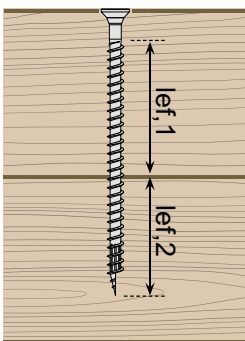

S-WCF-H Z – Full threaded screw with countersunk head: 45° loads



Thread type – Full threaded

Diameter Ø 10 mm		Axial 45°			Shear 45°		Item no.
		Cross-type screw fitting $l_{ef} = b/2$			Timber to timber $l_{ef} = b/2$	Metal to timber $l_{ef} = b$	
Description	L/b [mm]	$F_{v,X1,Rk}$ [kN]	$F_{v,X2,Rk}$ [kN]	$F_{v,X3,Rk}$ [kN]	$F_{v,Rk}$ [kN]	$F_{v,Rk}$ [kN]	
S-WCF-H-10x120 Z	120/108	9.55	17.18	25.77	5.97	11.93	2363586
S-WCF-H-10x160 Z	160/148	13.08	23.55	35.32	8.18	16.35	2363587
S-WCF-H-10x180 Z	180/168	14.85	26.73	40.09	9.28	18.56	2363588
S-WCF-H-10x200 Z	200/188	16.62	29.91	44.87	10.39	20.77	2363589
S-WCF-H-10x220 Z	220/208	18.38	33.09	49.64	11.49	22.98	2363590
S-WCF-H-10x240 Z	240/228	20.15	36.27	54.41	12.60	25.19	2363591
S-WCF-H-10x260 Z	260/248	21.92	39.46	59.18	13.70	27.4	2363592
S-WCF-H-10x280 Z	280/268	23.69	42.64	63.96	14.81	29.61	2363593
S-WCF-H-10x300 Z	300/288	24.86	44.75	67.12	15.91	31.82	2363594
S-WCF-H-10x325 Z	325/301	25.44	45.78	68.68	16.63	33.26	2363595
S-WCF-H-10x350 Z	350/326	26.54	47.77	71.66	18.01	35.36	2363596
S-WCF-H-10x375 Z	375/351	27.64	49.76	74.64	19.39	35.36	2363597
S-WCF-H-10x400 Z	400/376	28.75	51.75	77.62	20.77	35.36	2363598
S-WCF-H-10x450 Z	450/426	30.96	55.73	83.59	23.53	35.36	2363599
S-WCF-H-10x500 Z	500/476	33.17	59.70	89.56	26.30	35.36	2363600
S-WCF-H-10x580 Z	580/577	33.17	59.70	89.56	26.30	35.36	2372404

S-WXF-S Z and S-WXF-H Z – Full threaded screw with cylindrical head

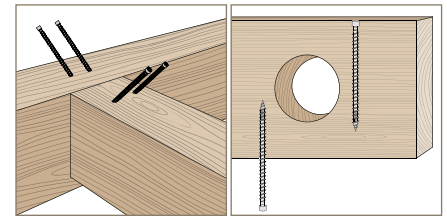

- Help to reduce the wood-splitting effect
- The screw head design allows penetration deep into the timber structure
- The screw portfolio includes half-tip design (S-WXF-H) and full-tip design (S-WXF-S)

Item name	d [mm]	L [mm]	Thread length b [mm]	Head Ø d _k [mm]	Recess drive	Pcs. per box	Item number
S-WXF-S-8x120 Z	8.0	120	110	10.2	TX 40	50	2363601
S-WXF-S-8x140 Z		140	130			50	2363602
S-WXF-S-8x160 Z		160	150			50	2363603
S-WXF-S-8x180 Z		180	170			50	2363604
S-WXF-S-8x200 Z		200	190			50	2363605
S-WXF-S-8x220 Z		220	210			50	2363606
S-WXF-S-8x240 Z		240	230			50	2363607
S-WXF-S-8x260 Z		260	250			50	2363608
S-WXF-S-8x280 Z		280	270			50	2363609
S-WXF-S-8x300 Z		300	290			50	2363610
S-WXF-S-8x325 Z		325	315			50	2363611
S-WXF-S-8x350 Z		350	340			50	2363612
S-WXF-S-8x375 Z		375	365			50	2363613
S-WXF-S-8x400 Z		400	390			50	2363614
S-WXF-S-8x500 Z	500	477	25	2372403			
S-WXF-H-10x200 Z	10	200	188	13.4	TX 50	50	2363615
S-WXF-H-10x240 Z		240	228			50	2363616
S-WXF-H-10x260 Z		260	248			50	2363617
S-WXF-H-10x280 Z		280	268			50	2363618
S-WXF-H-10x300 Z		300	288			50	2363619
S-WXF-H-10x325 Z		325	301			50	2363510
S-WXF-H-10x350 Z		350	326			50	2363511
S-WXF-H-10x375 Z		375	351			50	2363512
S-WXF-H-10x400 Z		400	376			50	2363513
S-WXF-H-10x450 Z		450	426			25	2363514
S-WXF-H-10x500 Z		500	476			25	2363515

S-WXF-S Z and S-WXF-H Z – Full threaded screw with cylindrical head

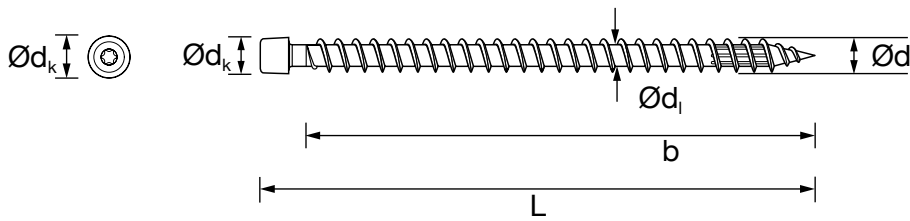

GEOMETRY AND MECHANICAL CHARACTERISTICS for C24 timber

Technical data:

Nominal diameter	d [mm]	Ø8	Ø10
Head diameter	d _k [mm]	10.2	13.4
Shank diameter	d _i [mm]	5.1	6.30
Characteristic withdrawal parameter	f _{ax,k,90°} [N/mm ²]	13.1	12.5
Characteristic head pull-through parameter	f _{head,k} [N/mm ²]	0	0
Characteristic tensile strength	f _{tens,k} [kN]	24.1	40.0
Characteristic yield moment	M _{y,k} [Nmm]	20300	36700
Characteristic buckling capacity	N _{pl,k · kc(*)} [kN]	12.2	18.9

*) total screw length in timber

Values for C24, axial axis to grain: 30°–90°, F_{ax,Rk} = thread withdrawal, F_{head,Rk} = head pull through, F_{v,Rk} = shear (// to grain 0°–⊥ to grain 90°), timber/steel plate: l_{ef} = thread length b, t_{1 min} = minimum timber thickness, t_{1 max} = maximum timber thickness, add-on part (L-b), F_{v,Rk,thin} = steel sheet t ≤ d/2, F_{v,Rk,thick} = steel sheet t ≥ d

Type and printing errors reserved. The values stated are meant to serve as planning guides; projects should only be undertaken by authorized professionals.

S-WXF-S Z and S-WXF-H Z – Full threaded screw with cylindrical head: loads



Thread type – Full threaded

Diameter Ø 8 mm		Axial 90°	Shear 90°	Item no.
		Pull-through $l_{ef} = b/2$	Timber to timber $l_{ef} = b/2$	
Description	L/b [mm]	$F_{ax,Rk}$ [kN]	$F_{v,Rk}$ [kN]	
S-WXF-S-8x120 Z	120/110	5.76	4.01	2363601
S-WXF-S-8x140 Z	140/130	6.81	4.27	2363602
S-WXF-S-8x160 Z	160/150	7.86	4.54	2363603
S-WXF-S-8x180 Z	180/170	8.91	4.80	2363604
S-WXF-S-8x200 Z	200/190	9.96	5.06	2363605
S-WXF-S-8x220 Z	220/210	11.00	5.14	2363606
S-WXF-S-8x240 Z	240/230	12.05	5.14	2363607
S-WXF-S-8x260 Z	260/250	13.10	5.14	2363608
S-WXF-S-8x280 Z	280/270	14.15	5.14	2363609
S-WXF-S-8x300 Z	300/290	15.20	5.14	2363610
S-WXF-S-8x325 Z	325/315	16.51	5.14	2363611
S-WXF-S-8x350 Z	350/340	17.82	5.14	2363612
S-WXF-S-8x375 Z	375/365	19.13	5.14	2363613
S-WXF-S-8x400 Z	400/390	20.44	5.14	2363614
S-WXF-S-8x500 Z	500/477	24.10	5.14	2372403

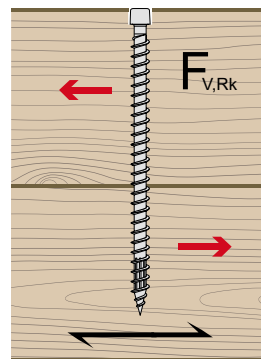
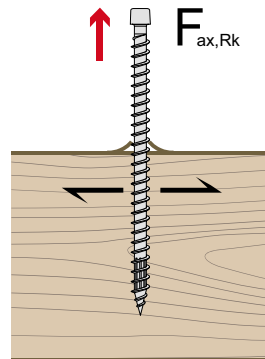
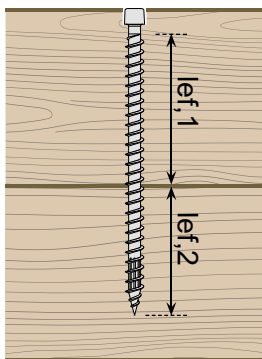

S-WXF-S Z and S-WXF-H Z – Full threaded screw with cylindrical head: loads



Thread type – Full threaded

Diameter Ø 10 mm		Axial 90°	Shear 90°	
		Pull-through $l_{ef} = b/2$	Timber to timber $l_{ef} = b/2$	
Description	L/b [mm]	$F_{ax,Rk}$ [kN]	$F_{v,Rk}$ [kN]	Item no.
S-WXF-H-10x200 Z	200/188	11.75	6.67	2363615
S-WXF-H-10x240 Z	240/228	14.25	7.30	2363616
S-WXF-H-10x260 Z	260/248	15.50	7.47	2363617
S-WXF-H-10x280 Z	280/268	16.75	7.47	2363618
S-WXF-H-10x300 Z	300/288	18.00	7.47	2363619
S-WXF-H-10x325 Z	325/301	18.81	7.47	2363510
S-WXF-H-10x350 Z	350/326	20.38	7.47	2363511
S-WXF-H-10x375 Z	375/351	21.94	7.47	2363512
S-WXF-H-10x400 Z	400/376	23.50	7.47	2363513
S-WXF-H-10x450 Z	450/426	26.63	7.47	2363514
S-WXF-H-10x500 Z	500/476	29.75	7.47	2363515

S-WXF-S Z and S-WXF-H Z – Full threaded screw with cylindrical head: 45° loads



Thread type – Full threaded

Diameter Ø 8 mm		Axial 45°			Shear 45°	Item no.
		Cross-type screw fitting $l_{ef} = b/2$			Timber to timber $l_{ef} = b/2$	
Description	L/b [mm]	$F_{v,X1,Rk}$ [kN]	$F_{v,X2,Rk}$ [kN]	$F_{v,X3,Rk}$ [kN]	$F_{v,Rk}$ [kN]	
S-WXF-S-8x120 Z	120/110	8.15	14.67	22.01	5.09	2363490
S-WXF-S-8x140 Z	140/130	9.63	17.34	26.01	6.02	2363491
S-WXF-S-8x160 Z	160/150	11.12	20.01	30.01	6.95	2363492
S-WXF-S-8x180 Z	180/170	12.60	22.68	34.01	7.87	2363493
S-WXF-S-8x200 Z	200/190	14.08	25.34	38.02	8.80	2363494
S-WXF-S-8x220 Z	220/210	15.56	28.01	42.02	9.73	2363495
S-WXF-S-8x240 Z	240/230	16.58	29.84	44.76	10.65	2363496
S-WXF-S-8x260 Z	260/250	17.32	31.17	46.76	11.58	2363497
S-WXF-S-8x280 Z	280/270	18.06	32.51	48.76	12.51	2363498
S-WXF-S-8x300 Z	300/290	18.80	33.84	50.76	13.43	2363499
S-WXF-S-8x325 Z	325/315	19.73	35.51	53.26	14.59	2363580
S-WXF-S-8x350 Z	350/340	20.65	37.18	55.76	15.75	2363581
S-WXF-S-8x375 Z	375/365	21.58	38.84	58.26	16.91	2363582
S-WXF-S-8x400 Z	400/390	22.51	40.51	60.77	18.06	2363583
S-WXF-S-8x500 Z	500/477	25.10	45.17	67.76	21.30	2363584

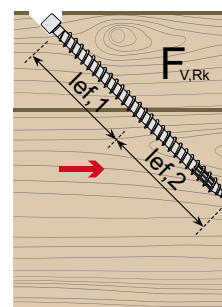
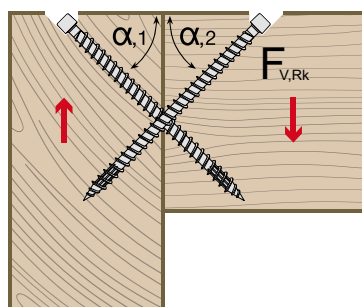
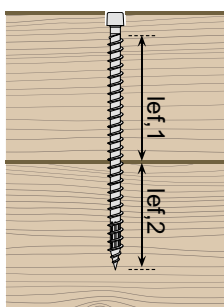

S-WXF-S Z and S-WXF-H Z – Full threaded screw with cylindrical head: 45° loads



Thread type – Full threaded

Diameter Ø 10 mm		Axial 45°			Shear 45°	Item no.
		Cross-type screw fitting $l_{ef} = b/2$			Timber to timber $l_{ef} = b/2$	
Description	L/b [mm]	$F_{v,X1,Rk}$ [kN]	$F_{v,X2,Rk}$ [kN]	$F_{v,X3,Rk}$ [kN]	$F_{v,Rk}$ [kN]	
S-WXF-H-10x200 Z	200/188	16.62	29.91	44.87	10.39	2363490
S-WXF-H-10x240 Z	240/228	20.15	36.27	54.41	12.60	2363491
S-WXF-H-10x260 Z	260/248	21.92	39.46	59.18	13.70	2363492
S-WXF-H-10x280 Z	280/268	23.69	42.64	63.96	14.81	2363493
S-WXF-H-10x300 Z	300/288	24.86	44.75	67.12	15.91	2363494
S-WXF-H-10x325 Z	325/301	25.44	45.78	68.68	16.63	2363495
S-WXF-H-10x350 Z	350/326	26.54	47.77	71.66	18.01	2363496
S-WXF-H-10x375 Z	375/351	27.64	49.76	74.64	19.39	2363497
S-WXF-H-10x400 Z	400/376	28.75	51.75	77.62	20.77	2363498
S-WXF-H-10x450 Z	450/426	30.96	55.73	83.59	23.53	2363499
S-WXF-H-10x500 Z	500/476	33.17	59.70	89.56	26.30	2363580

S-WDF-S Z – Full threaded screw with dual head



- With the HEX (hexagonal) recess to provide better torque transfer
- An additional TX (TORX) drive saves the time of changing tools

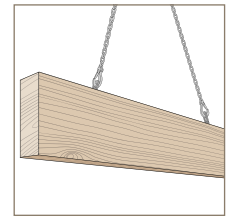

Item name	d [mm]	L [mm]	Thread length b [mm]	Head Ø d _k [mm]	Recess drive	Pcs. per box	Item number
S-WDF-S-12x60/48 Z	12	60	48	17	17 mm	30	2363666
S-WDF-S-12x80/68 Z		80	68			30	2363667
S-WDF-S-12x100/85 Z		100	85			30	2363668
S-WDF-S-12x120/105 Z		120	105			30	2363669
S-WDF-S-12x160/145 Z		160	145			30	2363670

S-WDF-S – Full threaded screw with dual head

GEOMETRY AND MECHANICAL CHARACTERISTICS for C24 timber

Technical data:

Nominal diameter	d [mm]	Ø12
Head diameter	d _k [mm]	17.0
Shank diameter	d _i [mm]	7.0
Characteristic withdrawal parameter	f _{ax,k,90°} [N/mm ²]	11.2
Characteristic head-pull-through parameter	f _{head,k} [N/mm ²]	17.1
Characteristic tensile strength	f _{tens,k} [kN]	45.0
Characteristic yield moment	M _{y,k} [Nmm]	48500

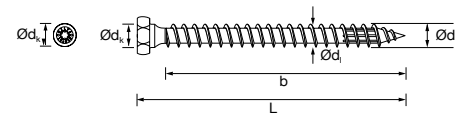

Values for C24 ($\rho_k = 350 \text{ kg/m}^3$), axial axis to grain: 30°–90°, $F_{ax,Rk}$ = thread withdrawal, $F_{head,Rk}$ = head pull through, $F_{v,Rk}$ = shear (// to grain 0°– \perp to grain 90°), timber/steel plate: l_{ef} = thread length b, $t_1 \text{ min}$ = minimum timber thickness, $t_1 \text{ max}$ = maximum timber thickness, add-on part (L-b), $F_{v,Rk,thin}$ = steel sheet $t \leq d/2$, $F_{v,Rk,thick}$ = steel sheet $t \geq d$

Type and printing errors reserved. The values stated are meant to serve as planning guides; projects should only be undertaken by authorized professionals.

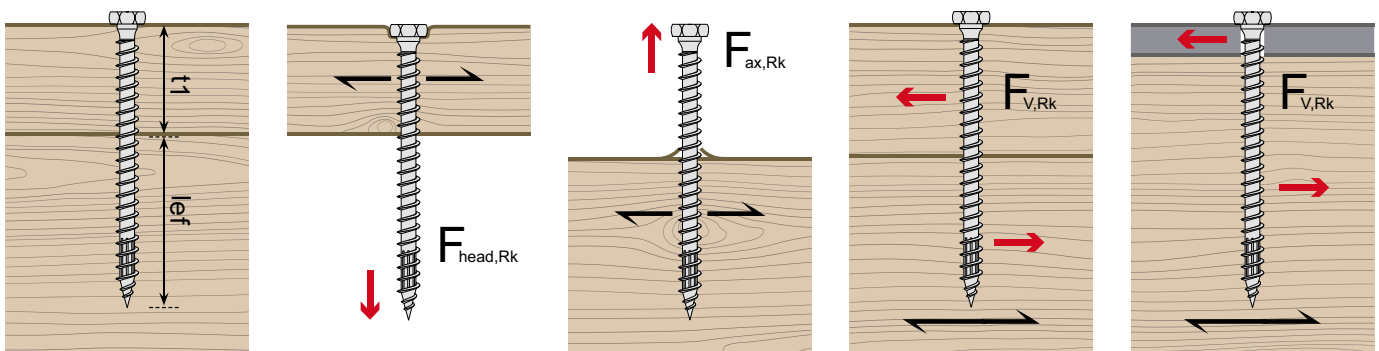

S-WDF-S Z – Full threaded screw with dual head: loads



Thread type – Full threaded

Diameter Ø 12 mm			Tension		Shear			Item no.
			Head pull-through	Thread withdrawal	Timber to timber	Steel to timber		
Description	L/b [mm]	t _{1,min} [mm]	F _{head,Rk} [kN]	F _{ax,Rk} [kN]	F _{v,Rk} [kN]	F _{v,Rk,thin} [kN]	F _{v,Rk,thick} [kN]	
S-WDF-S-12x60/48 Z	60/48		4.94	6.45	–	4.45	7.23	2363666
S-WDF-S-12x80/68 Z	80/68	–	4.94	9.13	–	5.75	8.38	2363667
S-WDF-S-12x100/85 Z	100/85	80	4.94	11.42	–	7.06	9.06	2363668
S-WDF-S-12x120/105 Z	120/105	80	4.94	14.11	–	7.86	9.73	2363669
S-WDF-S-12x160/145 Z	160/145	80	4.94	19.48	5.74	8.53	10.4	2363670

S-W LS – Lifting point solution



- Used together with S-WDF-S
- S-W Lifting system used in constructive timber work as a lifting system for prefabricated roofs, walls and ceilings, in timber frame construction for the prefab house industry, solid timber boards and cross laminated timber
- Suitable for cross-laminated timber, solid timber, coniferous timber-based materials (OSB, LVL etc.)
- Pre-drilling is recommended for deciduous timber structures
- Can be used for axial loads (screw subjected to tension) and transverse loads (screw subjected to shear-off stress)

Description	Item no.
S-W Lifting system	2372680

4. ADDITIONAL TECHNICAL INFORMATION

For drilled holes and punched holes: The Hilti S-WDF-S Z Dual Head is suitable. The screw automatically centers while screwing in and results in a perfect fit.

S-WDF-S Z Dual Head

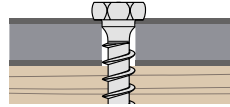

Ø 12 mm

ø d = 12mm

90° countersunk drilled holes:

Provide the countersunk head with sufficient support on the chamfer. Washer head screws also require a chamfer due to the rounding: $1.5 \cdot d$ is recommended.

The screw automatically centers while screwing in.

We recommend $d +0/+1$ mm for the cylindrical drilled hole in the metal (d = outer screw diameter)

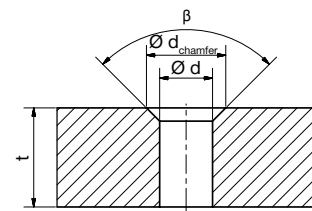

If the countersunk head should be fully countersunk into the metal, d_{chamfer} must be designed with a countersinking depth of 2 mm:

$$d_{\text{chamfer}} = d \cdot 1.5 \text{ in mm}$$

d = diameter of drilled hole in mm

d_{chamfer} = diameter of chamfer in mm

Hilti S-WCF-H Z and S-WCP-S Z countersunk head

	d_{chamfer}	Countersinking depth
Ø 6 mm	Min. 15 mm	
Ø 8 mm	Min. 15 mm	
Ø 10 mm	Min. 19 mm	
Ø 12 mm	Min. 21 mm	

Oblique drilled holes:

Predominantly, 45° oblique drilled holes are used in timber engineering. The design ensures the countersunk head will comply with ETA-22/0772, which is suitable for metals with $t \geq 10$ mm.

Characteristic values for the calculation of metal/timber connections should be taken from the tables in this brochure. Definition according to EC5 (EN1995-1-1)

- Thin metal sheet: sheet thickness $t \leq 0.5 \cdot d$ (outer thread diameter)
- Thick metal sheet: sheet thickness $t \geq d$ (outer thread diameter)
- Sheet thicknesses between $t \leq 0.5 \cdot d$ and $t \geq d$ should be interpolated linearly

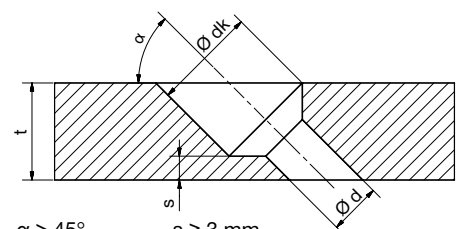

$$\alpha > 45^\circ \quad s \geq 3 \text{ mm}$$

$$30^\circ \leq \alpha \leq 45^\circ \quad s \geq 2 \text{ mm}$$

Minimum spacing, end distance, edge distance

Load type		Axially loaded screws		Axially and/or laterally loaded screws				Axially and/or laterally loaded screws	
Timber type		Softwood (predrilled and non predrilled) and hardwood (predrilled)		Softwood (predrilled and non predrilled) and hardwood (predrilled)				Cross laminated timber CLT	
Screw type		Screws with full tip $d \leq 8$ mm S-WCP-S, S-WWP-S, S-WXF-S Screws with half tip all diameter S-WCF-H, S-WXF-H		Screws with full tip all diameter S-WCP-S, S-WWP-S, S-WXF-S, S-WDF-S Screws with half tip all diameter S-WCF-H, S-WXF-H				Screws with full tip all diameter S-WCP-S, S-WWP-S, S-WXF-S, S-WDF-S Screws with half tip all diameter S-WCF-H, S-WXF-H	
		Side grain and end grain		Side grain and end grain				Wide face	Narrow face
Boundary condition	$a_1 \times a_2$	$\geq 25 d^2$	$\geq 21 d^2$	Angle α	Predrilled ²⁾ (softwood and hardwood)	Non predrilled (softwood)		-	-
					All screws	Screws with full tip ¹⁾	Screws with half tip ²⁾		
Spacing (parallel to grain)	a_1	$\geq 5 d$	$7 d$	$0^\circ \leq \alpha \leq 360^\circ$	$(4 + l \cos \alpha) d$	$(5 + 7 l \cos \alpha) d$	$(4 + l \cos \alpha) d$	$4 d$	$10 d$
End distance	$a_{1,CG}$	$5 d$		-	-	-	-	-	-
Spacing (perpendicular to grain)	a_2	$\geq 2.5 d$	$3 d$	$0^\circ \leq \alpha \leq 360^\circ$	$(3 + l \sin \alpha) d$	$5 d$	$(3 + l \sin \alpha) d$	$2.5 d$	$3 d$
Edge distance	$a_{2,CG}$	$4 d$		-	-	-	-	-	-
Distance (loaded end)	$a_{3,t}$	-		$-90^\circ \leq \alpha \leq 90^\circ$	$(7 + 5 \cos \alpha) d$	$(10 + 5 \cos \alpha) d^{3)}$	$(7 + 5 \cos \alpha) d$	$6 d$	$12 d$
Distance (unloaded end)	$a_{3,c}$	-		$90^\circ \leq \alpha \leq 270^\circ$	$7 d$	$10 d^{3)}$	$7 d$	$6 d$	$7 d$
Distance (loaded edge)	$a_{4,t}$	-		$0^\circ \leq \alpha \leq 180^\circ$	$(3 + 4 \sin \alpha) d$	$(5 + 5 \sin \alpha) d$	$(3 + 4 \sin \alpha) d$	$6 d$	$5 d$
Distance (unloaded edge)	$a_{4,c}$	-		$180^\circ \leq \alpha \leq 360^\circ$	$3 d$	$5 d^{4)}$	$3 d$	$2,5 d$	$3 d$
Spacing between crossing screws	a_{cross}	$1.5 d$		$1.5 d$				$1,5 d$	
Minimum timber thickness	t	$12 d^{5)}$		Screw diameter	< 8	8	10	12	$10 d$
				Minimum thickness t for structural members [mm] ⁵⁾	24	30	40	80	

¹⁾ Analogous to non predrilled nails according to EN 1995-1-1

²⁾ Analogous to predrilled nails according to EN 1995-1-1

³⁾ For screws with outer thread diameter $d \geq 8$ mm in non predrilled holes in wood based members with thickness $t < 5 d$, the minimum distances for loaded ends ($a_{3,t}$) and unloaded ends ($a_{3,c}$) shall be $15 d$.

⁴⁾ Minimum distances from the unloaded edge perpendicular to the grain ($a_{4,c}$) may be reduced to $3 d$ also for timber thickness $t < 5 d$, if the spacing parallel to the grain (a_1) and the end distance ($a_{3,t}$ and $a_{3,c}$) is at least $25 d$.

⁵⁾ For pre-drilled timber components, the specifications for the minimum timber thickness do not apply.

Table 4: Minimum spacing, end distance, edge distance

- If the minimum timber thickness t is not met, it should generally be predrilled.
- Predrilling diameter: d_i (-0.5/+1.0 mm) for softwood and d_i (-0/+1.0 mm) for hardwood and LVL.
- Timber at risk of splitting (e.g. Douglas fir, silver fir) must be pre-drilled according to EN 1995-1-1 or larger minimum thicknesses must be used.
- Drilled holes for positioning, guidance or orientation are NOT PREDRILLED.
- The minimum penetration length of screws shall be $4 d$, or $20 d$ in end grain.
- The minimum penetration length of screws in CLT shall be $4 d$ in the wide face or $10 d$ in the narrow face.

d = outer thread diameter of the screw

d_i = inner thread diameter of the screw

α = angle between force and grain direction. In ETA-22/0772 the angle is called ϵ .

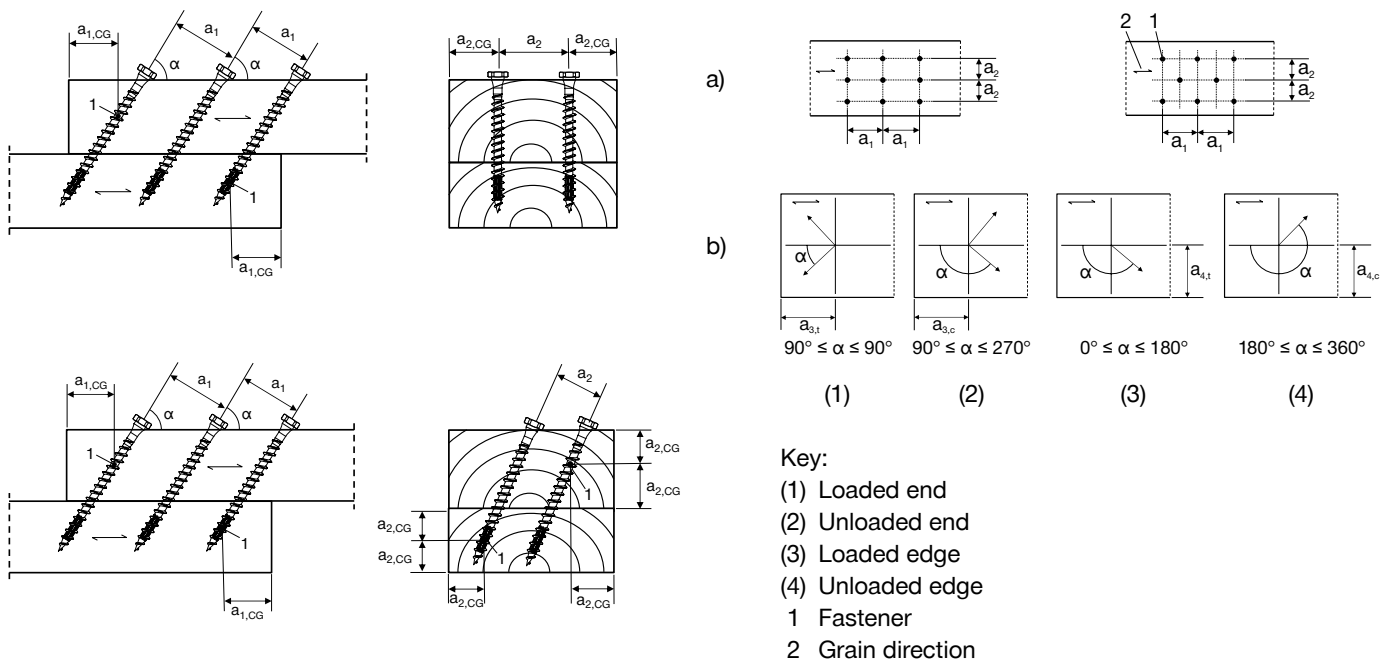

Figure 1: Spacing, end distance, edge distance acc. to EN 1995-1-1, Figure 8.11.a and Figure 8.7.

Important notes:

- Geometry and mechanical properties comply with ETA-22/0772.
- For connections of main and secondary beams, the main beam must have sufficient torsional strength and be supported by fork bearings.
- For connections of main and secondary beams, the values given apply only to vertical loads. Any transverse tensile stresses must be verified separately.
- The rope effect has been taken into account in the calculation of shear values.
- Characteristic values F_{Rk} : design according to EN 1995-1-1 and ETA-22/0772, these values are to be used for calculations.
- The design value of the load-bearing capacity $F_{v,Rd}$ for the final design of the timber connection results from the characteristic values as follows:

$$F_{Rd} = \frac{F_{Rk} \cdot k_{mod}}{\gamma_M}$$

- F_{Rd} Design value of the shear or tensile load capacity per fastener
- F_{Rk} Characteristic value of the shear or tensile load capacity per fastener
- γ_M, k_{mod} Factors from corresponding national standards

4.1 Introduction

The S-W lifting system (HILTI S-W LS) has applications in constructive timber work as a lifting system. It is designed for safer and easier lifting of timber components made of solid wood, cross laminated timber (CLT), glued laminated timber (glulam), or timber-based materials with CE marking (cf. materials listed in ETA-22/0772). For hardwood, we advise using the fasteners with predrilled holes. The system's flexibility allows for the application of both tension and shear stresses, opening up a wide range of uses.

Timber components are understood to be:

- bar-shaped components
- panel-shaped parts
- composite structures (e.g. trusses, prefabricated house walls or ceiling elements).

4.1.1 Picture showing the serial number

The self-drilling S-WDF-S screw, certified under ETA-22/0772, must be used with the HILTI S-W LS ball head. The lifting system is intended for weight classes up to 1.3 t.

In accordance with EG Machine Directive 2006/42/EG, Annex II 1A (EN 13001-1, EN ISO 12100:2011-03, VDI/BV-BS 6205:2012-04). The production is monitored and externally reviewed.

References:

EN 1995-1-1, ETA-22/0772

BGR 500/UUV-VBG 9a (German accident prevention regulation)



4.2 Safety information and intended use

These operating instructions must be thoroughly read before using the HILTI S-W LS and the user should always have access to them for reference whilst using it.

Only trained individuals (hereinafter referred to as "users") are permitted to perform lifting activities with the described HILTI S-W LS. The users must receive both theoretical and hands-on instruction in how to use the system properly before it initially goes into service. The HILTI S-W LS helps to improve the level of safety clearly when used acc. to the Instruction For Use. This effectively rules out any prior excess load.

- The S-WDF-S screw may only be screwed in once and loaded multiple times in this position (i.e., moving between stations in the factory and on the jobsite).
- Used screws must be left in the component or removed and discarded according to local recycling guidelines.
- Multiple usage of the screw results in risk of failure of the screw.
- The weights of the components to be lifted must be known exactly.
- Only S-WDF-S screws calculated according to chapter 4.4 may be used. The length of the screw thread limits the load capacity of the HILTI S-W LS.
- The screws must not be screwed into shrinkage cracks, joints or similar.
- Bar-shaped components (beams) are to be lifted with at least two S-WDF-S screws. For plate-shaped components at least three S-WDF-S screws must be used.

The self-drilling S-WDF-S screw is to be screwed into softwood without predrilling (see ETA-22/0772, e.g. solid wood, LVL, glulam, board and beam plywood, etc.), but can also be partially predrilled with max. Ø 7 mm, e.g. guide and orientation hole, or completely predrilled. Use in hardwood is only permitted with Ø 7 mm predrilling. For board plywood walls, follow the instructions in the load table for walls (narrow side) in chapter 4.5. The permissible mounting positions of the HILTI S-W LS are listed in chapter 4.4 and must be observed.

Use of the HILTI S-W LS during lifting operations and transport by helicopter is not permitted.

4.2.1 Visual and yearly inspection of the HILTI S-W LS

Before each use, the HILTI S-W LS must be visually inspected by the user for damage to help to ensure a safer lifting process. Therefore, the user must visually check for possible cracks in both parts of the lifting system (ball head and chain link). Also, the user must check for plastic deformations – e. g., a bent chain link ($> 5^\circ$), heavy wear, indentations, deformations, pressure marks caused by slings, etc. If any of these damages are observed, further use is not permitted.

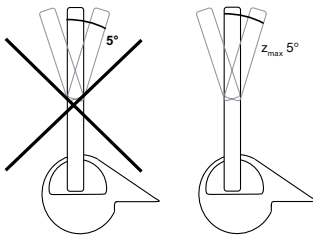

Figure 2: Bent chain link

The HILTI S-W LS must be inspected annually by the safety representative of the user's company. The degree of wear and damage must be assessed checking the dimensions m , h , c , g and z as shown below. Exceeding the permissible wear dimensions shown in the table below (wear higher than maximum value or dimension or remaining material dimension smaller than the minimum value) leads to exclusion of the ball head and chain link from further use. Modifications and repairs are not permitted. The yearly inspection must be documented together with the identification number linking to the ball head and chain link.

m (min.)	h (max.)	$\varnothing c$ (min.)	g (min.)	max. bending angle z_{max}
5.5 mm	13.0 mm	10.5 mm	14 mm	5°

Table 5: Dimensions to be checked in the yearly inspection

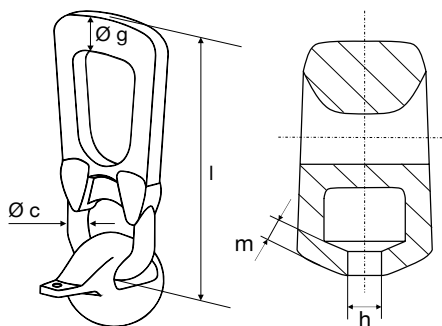
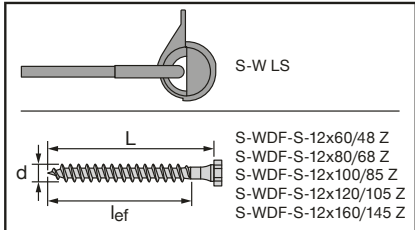
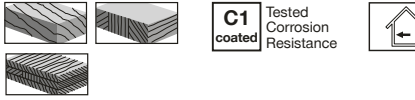
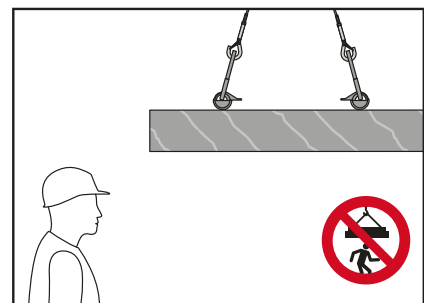
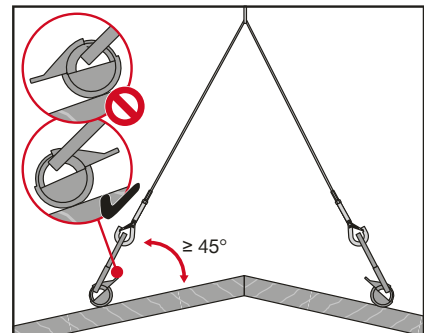
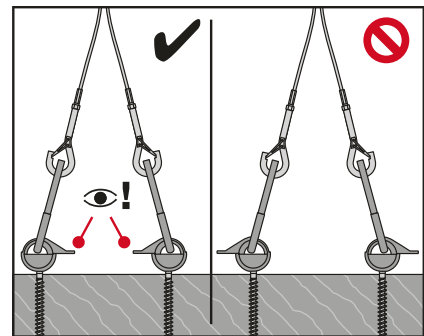
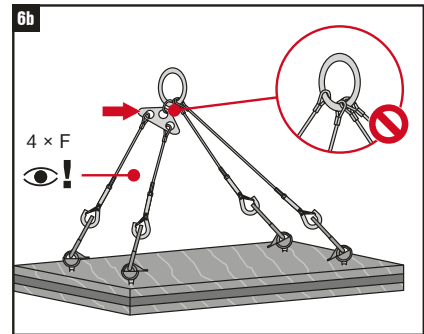
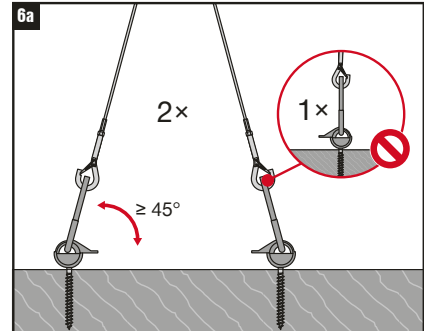
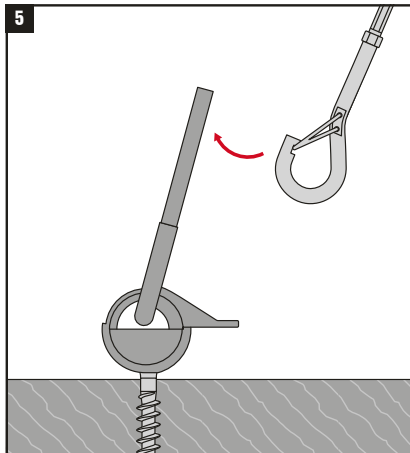
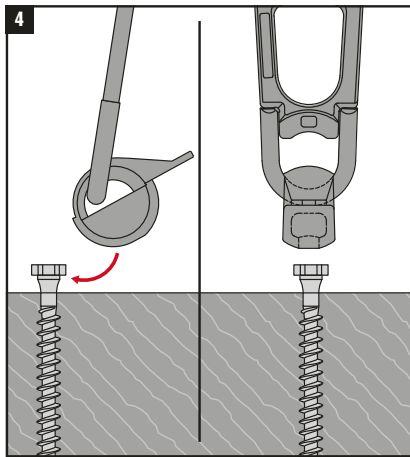
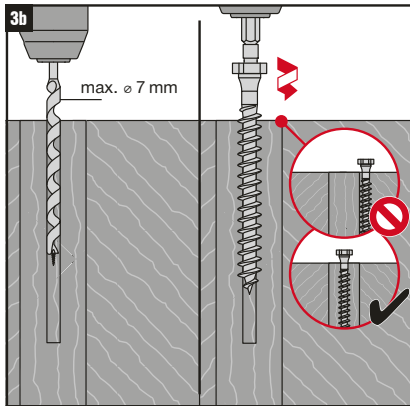
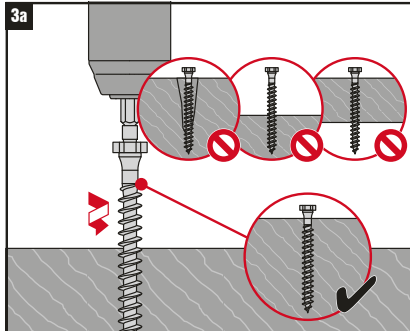
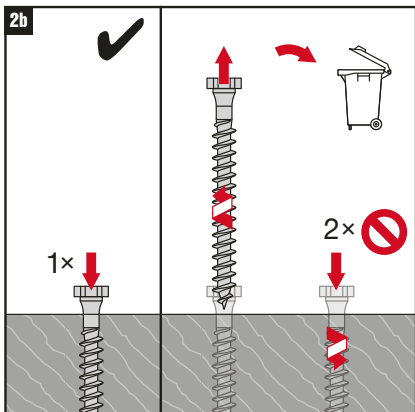
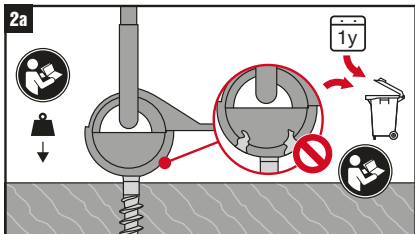
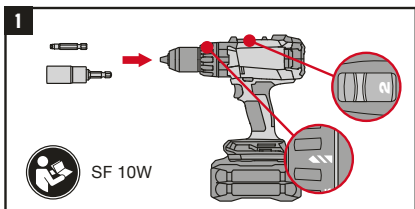

Figure 3: S-W LS with dimensions to be checked in yearly inspection



Dimension	lef
d × L	[mm]
∅ 12 × 60 mm	48
∅ 12 × 80 mm	68
∅ 12 × 100 mm	85
∅ 12 × 120 mm	105
∅ 12 × 160 mm	145

	SF 10W
	TX 40
	SW 17



4.3 Lifting with a crane

The load capacity of the HILTI S-W LS is determined by the minimum of the load capacities of all system components (ball head, chain link and screw). The weight forces acting on the HILTI S-W LS $F_{ax,Ed}$ can be interpreted as a quasi-static load when the timber components are lifted in accordance with the Hilti S-W LS operating instruction.. This means that the limitation stipulated in ETA-22/0772 of the S-WDF-S screw to predominantly static loads can be considered as fulfilled. The weight force of the timber component to be lifted must be determined according to EN 1991, national standards (e.g. DIN 1055-1) or specific manufacturer's specifications.

Dynamic loads during lifting can be taken into account in a simplified way by corresponding coefficients. As a recommendation, the acting forces are multiplied by the dynamic factor ϕ given in Table 6 as a minimum.

Lifting device	Lifting speed	Dynamic factor ϕ
Stationary crane, slewing or rail crane	≤ 90 m/min	1.0–1.1
	> 90 m/min	> 1.3
Lifting and transport on even ground	–	> 1.65
Lifting and transport on uneven ground	–	> 2.0

Table 6: Recommended dynamic factor ϕ

The hanging system is defined by the quantity of S-WDF-S screws. Statically indeterminate systems are basically hangers over 3 strands where the load is not evenly distributed by suitable measures, e.g. compensating crossbeams, rockers etc.

Statically indeterminate systems must be designed in accordance with BGR 500/UVV-VBG 9a so that two anchor points can support the complete load. The loads acting on the anchor points are to be determined by means of a triangle of forces.

Suitable measures (e.g. compensating traverses) can be used to design attachments with more than three anchor points in a statically determinate manner. In the case of statically determinate systems, all anchor points may be used to support the load.

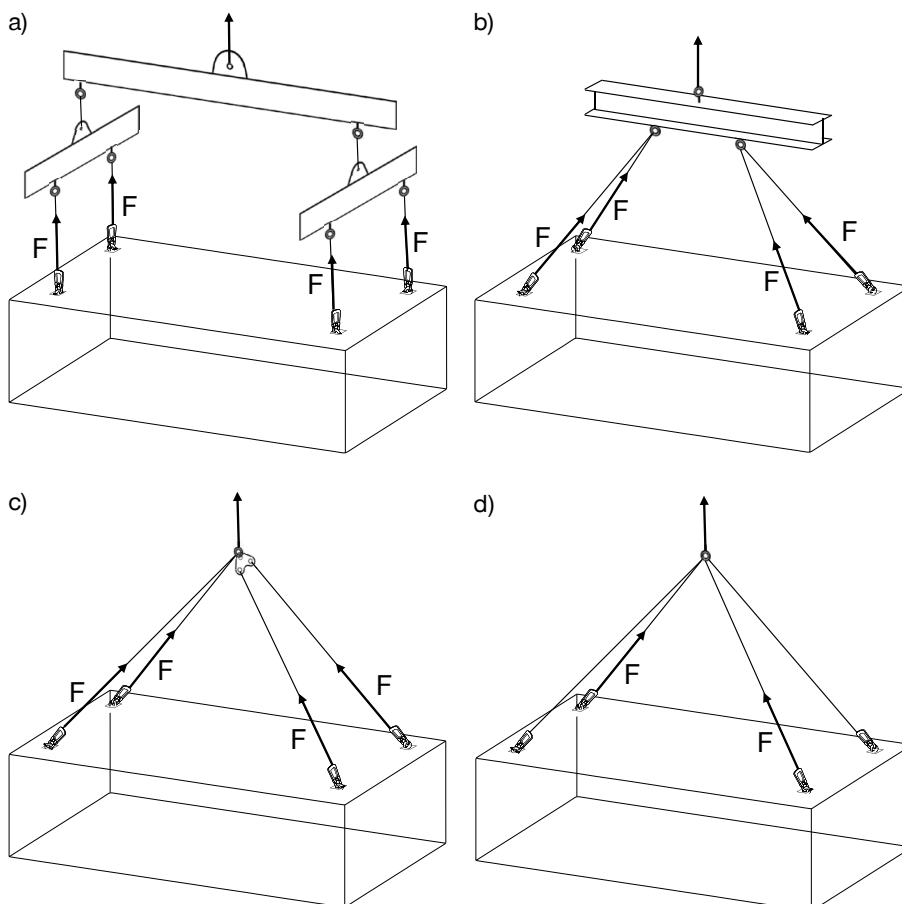

Figure 4: Three examples of statically determinate loads (a-c) and statically indeterminate load (d)

4.4 Design principles and calculations

The S-WDF-S screw can be mounted using 3 possible variants. These are:

4.4.1. Loading on the screw in axial tension

4.4.2. Loading of the screw on oblique tension

4.4.3. Loading on the screw due to oblique tension with accurately fitting milling for the ball head

The following symbols are used:

d	outer thread diameter in mm
l_{ef}	effective thread length in the timber component incl. thread tip in mm
ρ_k	characteristic value of wood density in kg/m^3
α	angle between screw axis and wood fiber direction in deg
$F_{ax,Rk}$	characteristic pull-out resistance of the S-WDF-S screw in N
$F_{ax,Rd}$	axial pull-out resistance in design state in N
$F_{ax,Ek}$	characteristic design value of the load per screw in N
$F_{ax,Ed}$	load per screw in design state in N
k_{mod}	modification factor
$\gamma_{M,Timber}$	partial safety factor
ϕ	dynamic factor
M	lifting load (actual weight) per HILTI S-W LS in kg
g	gravitational constant in $\text{m}^3/(\text{kg}\cdot\text{s}^2)$

4.4.1. Loading on the screw in axial tension

When the screw is loaded to pull out in the axial direction of the screw, this is referred to as an axial tensile load (see Figure 5 below). In this case the following equation for screw-in angles from $\alpha = 45^\circ$ to 90° can be used.

$$(1) \quad F_{ax,Ed} = F_{ax,Ek} \times 1.35 = M \times g \times \phi / \sin \alpha \times 1.35$$

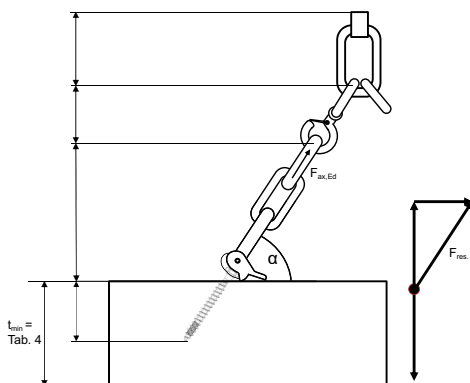

Figure 5: Axial tension load on the S-W LS

Calculation of the characteristic pull-out resistance in [N] e.g. For (C24, $\rho_k = 350 \text{ kg/m}^3$):

$$(2) \quad F_{ax,Rk} = 11.2 \text{ [N/mm}^2] \times d \times l_{ef} = 134.4 \times l_{ef}$$

These formulas apply to screws screwed in at an angle of $45^\circ \leq \alpha \leq 90^\circ$. For board plywood walls, follow the instructions in chapter 4.5. The effective thread length l_{ef} must be at least 48 mm. Applications with an angle smaller than 45° are possible but not recommended because of the high reduction of permissible loads (to be calculated by the responsible application engineer).

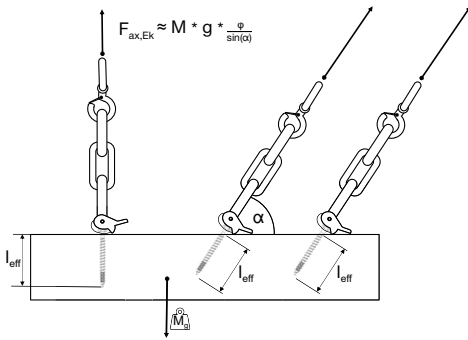

Figure 6: Axial load on the screw

Calculation of the design value of the pull-out resistance (C24, $\rho_k = 350 \text{ kg/m}^3$):

- (3) $F_{ax,Rd} = k_{mod} / \gamma_{M,timber} * F_{ax,Rk}$
 $k_{mod} = 0.9$ (wood moisture $\leq 20\%$). Further values for k_{mod} can be found in EN 1995-1-1. The value $k_{mod} = 1.1$ for KLED “very short” was not applied to increase the overall safety factor of applications.
 $\gamma_{M,Timber} = 1.3$ (for Italy this factor needs to be 1.5 according to UNI EN 1995-1-1 + NA)

Calculation of the maximum pull-out resistance $F_{ax,Rd}$ per S-WDF-S screw [N]:

- (4) $F_{ax,Rd} = 93.05 * l_{ef}$

A characteristic density of $\rho_k = 350 \text{ kg/m}^3$ applies. The determined load-bearing capacity must be corrected by the factor $k_{tens} = (\rho_k/350)^{0.8}$ (ρ_k in kg/m^3) for deviating gross densities.

The verification is performed by comparing the pull-out resistance $F_{ax,Rd}$ with the design value of the action $F_{ax,Ed}$:

- (5) $F_{ax,Ed} = 1.35 * F_{ax,Ek} \leq F_{ax,Rd} = 93.05 * l_{ef}$

For exact values of the load on the S-WDF-S screw, please refer to our lever load tables in chapter 3.

4.4.2 Loading of the S-WDF-S screw on oblique tension

When loading the S-WDF-S screw in axial and in transversal directions simultaneously, an oblique tension load is present (See Figure 7). The angle α must be at least 60° .

For the calculation of the characteristic shear resistance according to EN 1995-1-1, the failure mode of a thin single bar steel to timber connection is assumed, which amounts to 5.5 mm due to the wall thickness of the ball head.

- (6) $F_{v,Rk} = \min \left\{ \begin{array}{l} 0,4 f_{h,k} t_1 d \\ 1,15 \sqrt{2M_{y,Rk} f_{h,k} d} + \frac{F_{ax,Rk}}{4} \end{array} \right.$

- (7) $F_{v,Rd} = F_{v,Rk} * k_{mod} / \gamma_{M,timber}$

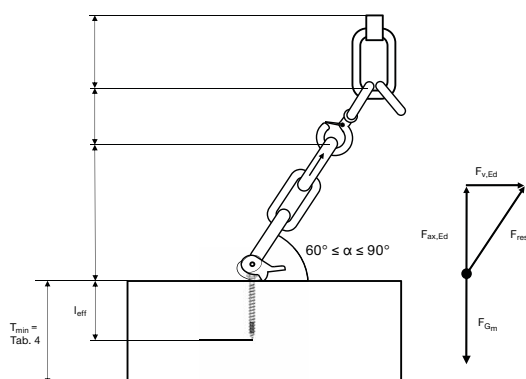

Figure 7: Oblique tension load on the screw

The verification is performed with this formula:

$$(8) \quad \left(\frac{F_{ax,Ed}}{F_{ax,Rd}} \right)^2 + \left(\frac{F_{v,Ed}}{F_{v,Rd}} \right)^2 \leq 1$$

- Characteristic yield moment of the screw: $M_{y,k} = 48500 \text{ Nmm}$
- Diameter $d_1 = 12 \text{ mm}$
- Modification factor for solid wood and wood materials $k_{mod} = 0.9$
- Partial factor for material property of solid wood and wood materials $\gamma_M = 1.3$ (Italy 1.5)
- Dynamic factor φ

With a characteristic density of at least $\rho_k = 350 \text{ kg/m}^3$ for perpendicular screws screwed into an edge is

$$(9) \quad f_{h,\alpha,k} = 0,082 * \rho_k * d_{0,3} / (2,5 * \cos_2\alpha + \sin^2\alpha) \dots \alpha = 90^\circ \text{ as in ETA-22/0772}$$

4.4.3 Loading on the screw due to oblique tension with accurately fitting milling for the ball head

With an accurately sunk ball head by means of a milling in the timber, the horizontal force of oblique tension is transferred directly into the timber. The loading therefore is equivalent to loading in axial tension and must be determined according to chapter 4.4.1.

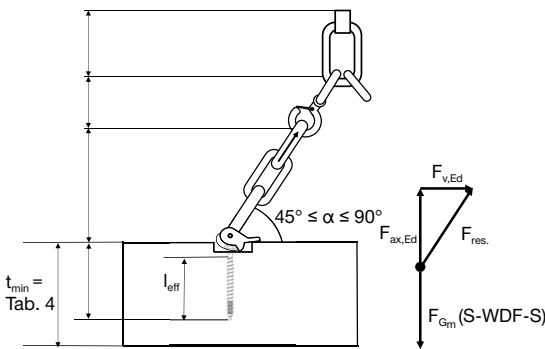

Figure 8: Axial load on the S-W LS with a fitting milling

The milling for the ball head must be created according to the measurements in Figure 9 using a forstner bit or an equivalent tool.

Milling diameter $d = 60\text{--}70 \text{ mm}$, depth 30 mm , optional predrilling of 60 mm depth.

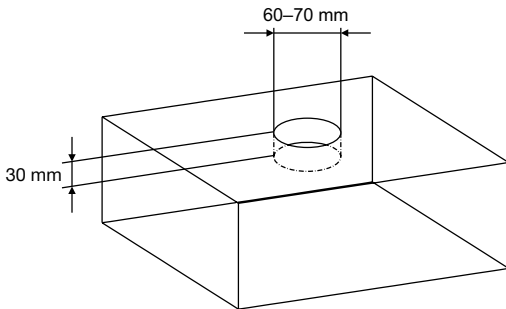

Figure 9: Milled hole for the ball head of the S-W LS

4.4.4 Screw spacing

A component must be lifted with at least two HILTI S-W LS ball heads. One S-WDF-S screw is required per anchor point for axial load. Timber components must have a minimum thickness t and a minimum width b according to ETA-22/0772. The values in Table 7 must be observed as minimum distances. Woods at risk of splitting (e.g. Douglas fir) require an increase in the minimum spacing in the direction of the grain by 50 %.

Screw spacing parameters		Minimum spacing or end/edge distance
Spacing between screws parallel to grain	$a_1 \geq 25 \times d$	300 mm
Spacing between screws perpendicular to grain	$a_2 \geq 5 \times d$	60 mm
Distance to the unloaded edge (perpendicular to grain)	$a_{4,c} \geq 4 \times d$	36 mm
Distance to the loaded edge (perpendicular to grain)	$a_{4,t} \geq 10 \times d$	120 mm
Distance to the loaded end (parallel to grain)	$a_{3,t} \geq 25 \times d$	300 mm
Minimum thickness for plate-shaped components	t	60 mm
Minimum width for beams	b_{min}	72 mm
Minimum width for walls	b_{min} CLT walls	60 mm

Table 7: Screw spacing parameters

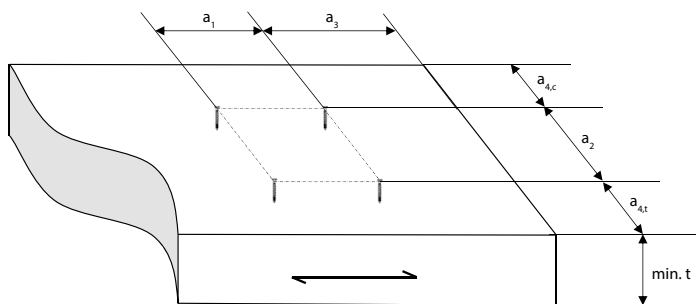

Figure 10: Screw distances

4.4.5 Lifting a flat element (wall, ceiling, etc.) with S-WDF-S screw

$$(10) \quad \left. \begin{array}{l} a_{4,t} \text{ (loaded edge, } \geq 10 \times d) = 120 \text{ mm} \\ a_{4,c} \text{ (unloaded edge, } \geq 3 \times d) = 36 \text{ mm} \end{array} \right\} \text{min } t = 156 \text{ mm}$$

NOTES to Figure 11: A mathematical verification must be done to check whether additional transverse tension securing with full threaded screws is required.

When lifting, bending of the S-WDF-S screw must be avoided (e.g. by countersinking the ball head).

Due to the combined load, the load-bearing capacity of the screw must be verified as specified in chapter 4.4.2.

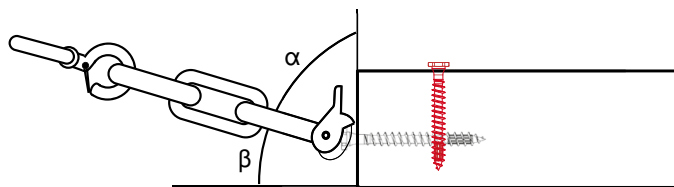

Figure 11: Lifting a horizontal element

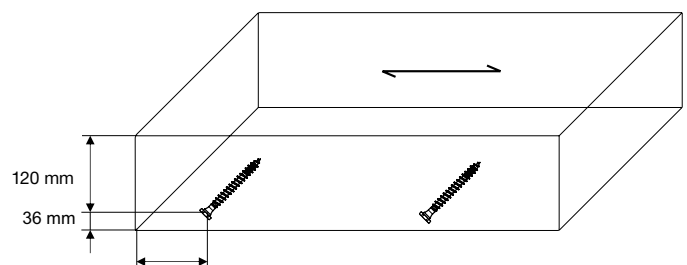

Figure 12: Placement of S-WDF-S screws in the narrow side of a element

4.5 Lifting load tables

4.5.1 Lifting loads for ceilings and beams

The lifting loads in Table 8 are based on the data given in the operating instructions above for S-WDF-S screws of Hilti AG or ETA -22/0772 and are valid for softwood (solid wood, glulam, cross laminated timber) with a characteristic gross density ρ_k of at least 350 kg/m³ and:

- Screw-in angle 90° to the lateral surface
- Compliance with the minimum distances according to ETA-22/0772
- Screwing the entire thread into the timber component to be lifted
- Only axial loading of the S-WDF-S screw (see Figure 13 and 14)
- One-time use of HILTI S-W LS
- Short loading duration (≤ 30 min)
- No excess of the load capacity of the HILTI S-W LS (1.3 t)

Maximum lifting load		Maximum lifting load M per per S-WDF-S screw			
		Stationary crane		Mobile crane	
		Lifting speed		Terrain conditions	
dimension	l_{ef}	≤ 90 m/min	> 90 m/min	Even ground	Uneven ground
D × L	[mm]	$\phi = 1.10$	$\phi = 1.30$	$\phi = 1.65$	$\phi = 2.00$
Ø 12 × 60 mm	48	307 kg	259 kg	204 kg	169 kg
Ø 12 × 80 mm	68	434 kg	368 kg	290 kg	239 kg
Ø 12 × 100 mm	85	562 kg	476 kg	375 kg	309 kg
Ø 12 × 120 mm	105	671 kg	567 kg	447 kg	369 kg
Ø 12 × 160 mm	145	926 kg	784 kg	617 kg	509 kg

Table 8: maximum load M (actual gross weight) per HILTI S-W LS screw for selected dynamic factor ϕ

The dynamic factor ϕ is influenced by various boundary conditions (crane type, acceleration, wind, ground, etc.) and must be selected by the user accordingly. The dynamic factor shown refers to this operating instruction.

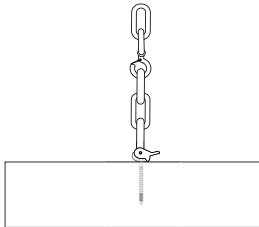

Figure 13: Purely axial loading of the screw by perpendicular rigging

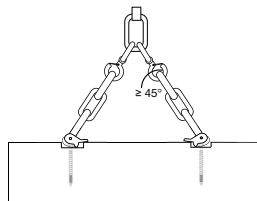

Figure 14: Purely axial loading of the screw through accurately fitting millings

Basis of the design calculation:

$$(11) \quad M \leq \min \left\{ \begin{array}{l} \text{thread stripping} \\ \text{screw shaft breakage} \\ \text{ball head load} \end{array} \right\} = \min \left\{ \frac{1}{g \cdot \gamma_G \cdot \phi} * \min \left\{ \frac{F_{ax,Rk} \cdot k_{mod}}{\gamma_M}, \frac{f_{tens,k}}{1,25} \right\} \right\} \text{ [kg]}$$

$$\text{with } F_{ax,Rk} = \frac{0,35 \times d^{0,8} \times l_{ef}^{0,9} \times \rho_k^{0,75}}{1,5} \text{ [N]}$$

$$f_{tens,k} = 45\,000 \text{ [N]}; k_{mod} = 0,9; \gamma_M = 1,3; \gamma_G = 1,35; g = 9,81 \left[\frac{m}{s^2} \right];$$

Correction factors for deviating gross densities			
Strength class	Norm	Gross density ρ_k	Factor
[-]	[-]	[kg/m ³]	[-]
C16	EN338	310	0.90
C24	EN338	350	1.00
C30	EN338	380	1.06
GL24c	EN14080	365	1.03
GL28c	EN14080	390	1.09
GL30c	EN14080	390	1.09
GL32c	EN14080	400	1.11
GL24h	EN14080	385	1.07
GL28h	EN14080	425	1.16
GL30h	EN14080	430	1.17
GL32h	EN14080	440	1.20

Note: The correction factor for the lowest strength class used shall be used.

Table 9: correction factors for deviating gross densities

4.5.2 Lifting loads for the narrow side of CLT wall elements

The lifting loads are based on the data given in this operating instruction and on ON B 1995-1-1:2019, Annex K and are valid for CLT made of softwood with a characteristic density ρ_k of the inner layers of at least 350 kg/m³ and:

- Screw-in angle 90° to the narrow face.
- Place the screw in the middle of the narrow face (regardless of the position of the board).
- Do not screw into joints or wood features (e.g. knots).
- Distance between wall element end and screw axis min 25*d (see Figure 15)
- Screw the entire length of the thread into the timber element to be lifted
- Only axial loading of the S-WDF-S screw (see Figure 15)
- One-time use of the S-WDF-S screw
- Short loading duration (≤ 30 min).
- Minimum thickness of the wall element: 60 mm
- Use of S-WDF-S-12×160/145 Z
- No excess of the load capacity of the HILTI S-W LS (1.3 t)

For stationary cranes the maximum lifting load M per S-WDF-S screw is:

- For a lifting speed smaller than 90 m/min ($\phi = 1.10$): 577 kg
- For a lifting speed higher than 90 m/min ($\phi = 1.30$): 489 kg

For mobile cranes the maximum lifting load M per S-WDF-S screw is:

- For Lifting and transport on even ground ($\phi = 1.65$): 385 kg
- For Lifting and transport on uneven ground ($\phi = 2.00$): 318 kg

The dynamic coefficient ϕ is influenced by various boundary conditions (crane type, acceleration, wind, ground, etc.) and must be selected by the user accordingly. The dynamic coefficients shown refer to this operating instruction.

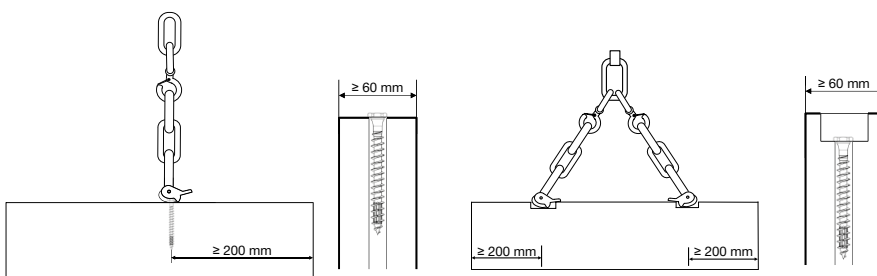

Figure 15: Minimum distances for screw placement for lifting CLT wall elements using the narrow side

Basis of the design calculation:

$$(12) \quad M \leq \min \left\{ \begin{array}{l} \text{thread stripping} \\ \text{screw shaft breakage} \\ \text{ball head load} \end{array} \right\} = \min \left\{ \frac{1}{9 \cdot \gamma_G \cdot \gamma_P} * \min \left\{ \frac{F_{ax,Rk} \cdot k_{mod}}{\gamma_M}, \frac{f_{tens,k}}{1.25} \right\} \right\} \text{ [kg]}$$

$$\text{with } F_{ax,Rk} = f_{ax,k,90} * l_{ef} * d * k_{ax} * k_{dens} \text{ [N]}$$

$$f_{ax,k,90} = 11.2 \left[\frac{\text{N}}{\text{mm}^2} \right]; f_{tens,k} = 45\,000 \text{ [N]}; k_{ax,(\alpha=90^\circ)} = 1.0; k_{dens,(\rho_k=350)} \left[\frac{\text{kg}}{\text{m}^3} \right] = 1.0; k_{mod} = 0.9; \gamma_M = 1.3; \gamma_G = 1.35;$$

$$g = 9.81 \left[\frac{\text{m}}{\text{s}^2} \right];$$

Correction factors for deviating gross densities			
Strength class	Norm	Gross density ρ_k	Factor
[-]	[-]	[kg/m ³]	[-]
C16	EN338	310	0.91
C24	EN338	350	1.00
C30	EN338	380	1.06

Note: The correction factor for the lowest strength class employed shall be used.

Table 10: correction factors for deviating gross densities.





5. TOOLS, INSERT BITS AND ACCESSORIES

Tool recommendations for structural timber screw applications

The usage of impact drills or impact wrenches with timber construction screws is neither regulated by EN 14592 nor by the European Technical Assessments, but national construction regulations may still apply. Cordless screwdrivers offering a high fastening speed are the recommended choice when fastening structural timber screws. Nevertheless, certain situations might require that a fastening is done one handed. In such cases, the question arises of whether the use of impact drills is allowed.

To answer this question a series of experiments were conducted to determine the effect of impact drills on Hilti structural timber screws. In these tests, when fastening timber (C24) to timber (C24) with the Hilti structural timber screws using a SID 4, 6 or 8, no damage to the screws was found.

The choice of the right power class of the tool depends on the type of timber, screw length, diameter and whether the hole is predrilled. In any case both impact drivers and screwdrivers can overturn timber screws and cause breakage of the screw or damage of the timber thread. Therefore, the personnel fastening structural timber screws must be trained. The end of the setting, when the screw head touches the timber, must be done with special care.

Screw type	Screw geometry (bit size)	SF tools SF 4, SF 6, SF10W		SID tools SID 4, SID 6, SID 8	
		Timber-to-timber	Metal-to-timber	Timber-to-timber	Metal-to-timber
 S-WCF-H Countersunk head, full thread	8 × 120-580 (TX40)	●	●	●	○
	10 × 120-580 (TX50)	●	●	●	○
 S-WXF-H/S Cylindric head, full thread	8 × 120-500 (TX40)	●		●	
	10 × 200-500 (TX50)	●		●	
 S-WWP-S Washer head, half thread	6 × 60-200 (TX30)	●	●	●	○
	8 × 80-580 (TX40)	●	●	●	○
	10 × 140-580 (TX50)	●	●	●	○
 S-WCP-S Countersunk head, half thread	5 × 40-100 (TX25)	●	●	●	○
	6 × 50-180 (TX30)	●	●	●	○
	8 × 80-400 (TX40)	●	●	●	○
	10 × 160-400 (TX50)	●	●	●	○
 S-WDF-S Dual head, full thread	12 × 60, 120, 180 (TX40/SW17)	●	●	●	○

- Recommended fastening method
- Works but watch out for overturning screws
- Not recommended → head and/or thread damage likely to happen

👁 **Watch-out for overturning screws or head breakage when using impact wrenches!**

Tools

Name	Type	Features	Picture	Item number
Cordless drill driver SF 4-22	Compact-class cordless drill driver with ATC (Active Torque Control) for everyday drilling and driving, especially in hard-to-reach places (NURON battery platform)	<ul style="list-style-type: none"> • Maximum torque (soft/hard joint): 36 Nm (soft joint), 62 Nm (hard joint) • No load RPM: gear 1: 610 rpm; gear 2: 2100 rpm • Chuck clamping range: 2–13 mm 		2343239
Cordless drill driver SF 6-22	Power-class drill driver with Active Torque Control and advanced ergonomics for universal drilling and driving on timber and metal (NURON battery platform)	<ul style="list-style-type: none"> • Maximum torque (soft/hard joint): 65 Nm (soft joint), 85 Nm (hard joint) • No load RPM: gear 1: 490 rpm; gear 2: 2000 rpm • Chuck clamping range: 2–13 mm 		2253844
Cordless drill driver SF 10W-22	Ultimate class 22 V cordless drill driver with Active Torque Control and four-speed gearing for high torque in demanding applications in timber and other materials	<ul style="list-style-type: none"> • Maximum torque (soft/hard joint): 95 Nm (soft joint) • No load RPM: gear 1: 330 rpm; gear 2: 560 rpm; gear 3: 1300 rpm; gear 4: 2130 rpm • Chuck clamping range: 1.5–13 mm 		2335696

Insert bits and accessories

Torsion bits:

- Elastic torsion zone in the bit shaft cushions higher loads to extend the product service life
- High-strength steel reduces the danger of premature bit breakage

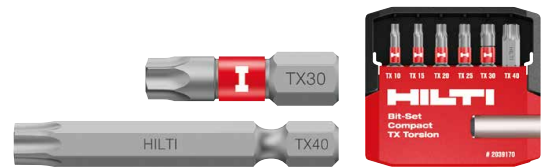

Insert bit	Recess type	Length [mm/inch]	Connection end	Pcs. per box	Item number
S-B TX25 25/1" T (10)	TX25	25/1"	1/4	10	2039059
S-B TX25 50/2" T (5)	TX25	50/2"		5	2039093
S-B TX30 25/1" T (10)	TX30	25/1"		10	2039062
S-B TX30 50/2" T (5)	TX30	50/2"		5	2039096
S-B TX40 50/2" T (5)	TX40	50/2"		5	2039097
S-B TX50 50/2" S (5)	TX50	50/2"		5	2039098
Set S-BSC TX 25/1" T (7)	TX10, TX15, TX20, TX25, TX30, TX40	25/1"		6	2039170
Set S-BSC TX 50/2" T (6)	TX20x2, TX25x2, TX30, TX40	50/2"	6	2039176	

Impact bits:

- Shock-resistant steel and torsion zone optimized for use with impact loads reduces the risk of premature bit breakage
- Diamond coating for a secure fit in the screw, reducing the likelihood of cam-out

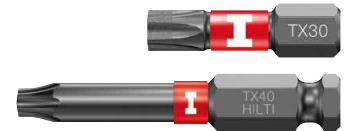

Insert bit	Recess type	Length [mm/inch]	Connection end	Pcs. per box	Item number
S-B TX25 25/1" IMP (10)	TX25	25/1"	1/4	10	2039121
S-B TX25 50/2" IMP (5)	TX25	50/2"		5	2039131
S-B TX30 50/2" IMP (5)	TX30	25/1"		10	2039132
S-B TX30 25/1" IMP (10)	TX30	50/2"		5	2039122
S-B TX40 25/1" IMP (10)	TX40	25/1"		10	2039123
S-B TX40 50/2" IMP (5)	TX40	50/2"		5	2039133
S-BSC TX 50/2" IMP (6)	TX20, TX25x2, TX30x2, TX40	50/2"	7/16	6	2039181
S-B TX30 7/16" 70 IMP-W	TX30	70/2 3/4"		5	2120653
S-B TX40 7/16" 70 IMP-W	TX40	70/2 3/4"		5	2120654
S-B TX50 7/16" 70 IMP-W	TX50	70/2 3/4"		5	2120656
Set S-BSC TX 7/16" 70 IMP-W	TX30x2, TX40x2, TX50	70/2 3/4"		5	2120657

Bit holders and adaptors:

- For driving screws into a variety of materials
- Perfect fit with Hilti tools, screws and insert bits



Bit holder	Type	Length [mm/inch]	Connection end	Pcs. per box	Item number
S-BH M 50/2"	Magnetic	50/2"	1/4	1	2038758
S-BH M 75/3"	Magnetic	75/3"		1	2038759
S-BH QC 50/2"	Quick chuck	50/2"		1	2039219
S-BH IMP 75/3" RM	Quick chuck/Impact	75/3"		1	2039216
Adapter SI-SA 1/2" - 7/16"	Adapter 1/2" - 7/16"	50/2"	1/2"	1	2094451



Hilti Corporation
9494 Schaan, Liechtenstein
P +423-234 2965

www.facebook.com/hiltigroup
www.hilti.group